

# Timers



Selection Guide.....	792
RTE Series — Analog Timers .....	798
Accessories .....	803
Dimensions .....	804
GT3A Series — Analog Timers .....	805
GT3D — Digital Timers .....	813
GT3F Series — True OFF Delay Timers.....	826
GT3S (Star-Delta) Timers .....	831
GT3W Series — Dual Time Range Timers .....	834
GT3 Series.....	838
Accessories .....	838
Dimensions .....	842
GE1A Series — ON Delay Timers .....	844
Accessories .....	846
Dimensions .....	847
GT5P Series — ON Delay Timers.....	848
Accessories .....	851
Dimensions .....	852
GT5Y Series — ON Delay Timers.....	853
Accessories .....	856
Dimensions .....	857
General Instructions for All Timer Series ..	858



For more information on this product family, visit our website.





Additional resources include:

- New and updated product information
- Downloadable software demos & upgrades
- Part configuration tool & cross reference
- Online stock check & ordering
- IDEC field sales & distributor search
- Online literature request
- Downloadable manuals & CAD drawings
- Manufacturer's suggested retail price list
- Product training schedule & locations
- Advertising & trade show schedules
- Press releases & FAQs

[www.idec.com/timer](http://www.idec.com/timer)

**Selection Guide**

**Selection Guide: RTE, GT3A, GT3D, and GT3F Series**

Series Model	RTE	GT3A	GT3D	GT3F
Page	798	805	813	826
Appearance				
Mode of Operation	ON-delay Interval OFF-delay One-shot Cycle (ON first) Cycle (OFF first) Signal OFF delay Signal ON/OFF delay	ON-delay Interval OFF-delay One-shot Cycle (off first) Cycle (on first) Signal OFF delay Signal ON/OFF delay	ON-delay Interval One-shot One-shot ON delay Cycle Signal OFF delay Signal ON/OFF delay	True OFF-delay
Time Range	0.1 second to 600 hrs	0.1 second to 180 hrs	0.01 second to 99.9 hrs	0.1 to 600 seconds
Contact Configuration	DPDT	SPDT, DPDT	SPDT, DPDT	SPDT, DPDT
Repeat Accuracy	±0.25% maximum	±0.2% maximum	±0.3% maximum	±0.4% maximum
Contact Load Rating (resistive)	10A, 240V AC	SPDT: 3A, 250V AC DPDT: 5A, 240V AC	SPDT: 3A, 250V AC DPDT: 5A, 240V AC	5A, 250V AC
Available Operating Voltage	100-240V AC 12V DC 24V AC/DC	100 to 240V AC 12V DC 24V AC/DC	100 to 240V AC 24V AC/DC	100 to 240V AC 24V AC/DC
Approvals	UL Listed c-uL Listed TUV CE	UL Listed c-uL Listed CE	UL recognized TUV CSA CE	UL Listed c-uL Listed CE

- 1. For Timing Diagrams Overview, see page 794.
- 2. For all series specific instructions, accessories, and dimensions, see the individual series section.

Switches & Pilot Lights

Display Lights

Relays & Sockets

Timers

Terminal Blocks

Circuit Breakers

Selection Guide

Selection Guide: RTE, GT3A, GT3D, and GT3F Series

Series Model	GT3S	GT3W	GE1A	GT5P	GT5Y
Page	831	834	844	848	853
Appearance					
Mode of Operation	Star-Delta	Sequential start ON-delay Recycler and instantaneous Recycler OFF start Recycler ON start Interval Interval ON delay Sequential interval	ON-delay	ON-delay	ON-delay
Time Range	Star side: 0.05s to 100s Star-delta Switching Time: 0.05, 0.1, 0.25, 0.5 seconds	0.1s to 300 hrs	0.1s to 10 hrs	0.1s to 10 minutes	0.1s to 1 hour
Contact Configuration	SPST-NO	DPDT	SPDT, DPDT	SPDT	DPDT, 4PDT
Repeat Accuracy	±0.2% maximum	±0.2% maximum	±0.2% maximum	±0.2% maximum	±0.2% maximum
Contact Load Rating (resistive)	5A, 250V AC/30VDC	3A, 250V AC 5A, 120V AC/30V DC	5A, 240V AC	5A, 250V AC	5A, DPDT: 250V AC 3A, 4PDT: 250V AC
Available Operating Voltage	100 to 240V AC	100 to 240V AC 12V DC 24V AC/DC	24V AC/DC 110 to 120V AC 220 to 240V AC	100 to 120V AC 200 to 240V AC 12V DC 24V DC	100 to 120V AC 200 to 240V AC 12V DC 24V DC 24V AC
Approvals	UL Listed c-uL Listed CE	UL Listed c-uL Listed CE	UL Listed c-uL Listed TUV CE	UL recognized TUV CSA CE	UL Listed c-uL Listed CE

- 1. For Timing Diagrams Overview, see page 794..
- 2. For all series specific instructions, accessories, and dimensions, see the individual series section.

Switches & Pilot Lights

Display Lights

Relays & Sockets

Timers

Terminal Blocks

Circuit Breakers

Timing Diagrams Overview

Guide to Reading Timing Function Diagrams

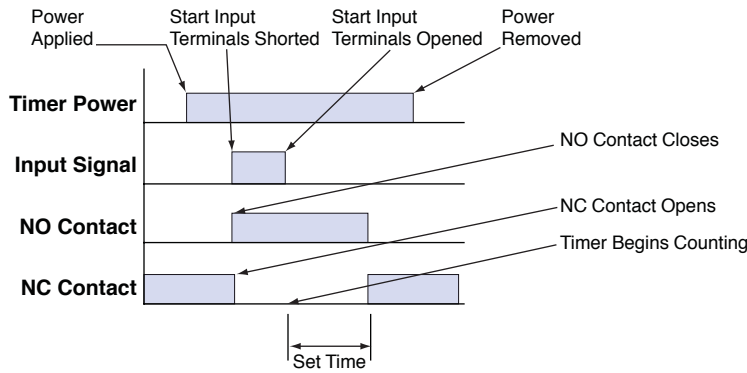

1. If power is disconnected during actual timing, most electronic timers reset to the preset time, ready for the re-application of supply voltage (except for GT3F "true OFF Delay").
2. NO = Normally open.
3. NC = Normally closed.

Timing Function Diagrams Overview

ON-Delay 1 (power start)

When voltage is applied to the coil, the relay contacts remain in the **off state** and the set time begins. When the set time has elapsed, the relay contacts transfer to the **on state**. The contacts remain in the on state until the timer is reset. The timer is reset by removing the coil voltage. Applicable models: RTE-P(B)1, GT3A-1, -2, -3, GT3D-1, -2, -3, -4, and GE1A.

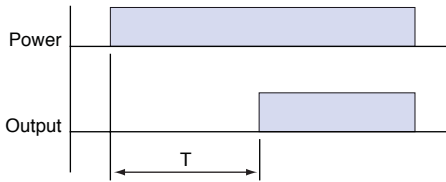

Type No.	GT3A-1, -2, -3	GT3D-1, -2, -3, -4	RTE-*1
Mode	A	1-A	A
See Page	805	813	798
Type No.	GE1A	GT5P	GT5Y
See Page	844	813	853

Interval 1 (power start)

When voltage is applied to the coil, the relay contacts transfer immediately to the **on state** and the set time begins. When the set time has elapsed, the relay contacts transfer to the **off state**. The contacts remain in the **off state** until the timer is reset. The timer is reset by removing the coil voltage. Applicable models: RTE-P(B)1, GT3A-1, -2, -3, and GT3D-1, -2, -3, -4.

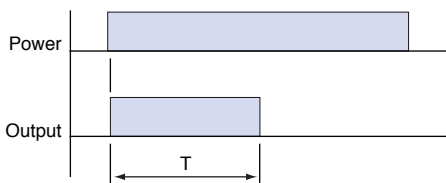

Type No.	GT3A-1, -2, -3	GT3D-1, -2, -3, -4	RTE-*1
Mode	B	1-B	B
See Page	805	813	798

ON-Delay 2 (signal start)

Voltage is applied to the coil at all times. When a start input is supplied, the relay contacts remain in the **off state** and the set time begins. When the set time has elapsed, the relay contacts transfer to the **on state**. The contacts remain in the **on state** until the timer is reset. The timer is reset by applying a reset input or by removing the coil voltage. Applicable models: GT3A-4, GT3D-4 and RTE-P(B) 2.

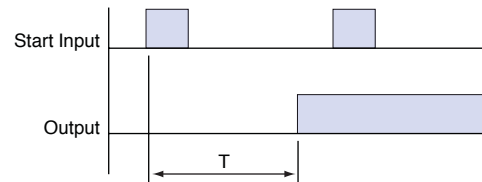

Type No.	GT3A-4	GT3D-4	RTE-*2
Mode	A	2-A	A
See Page	805	813	798

Interval 2 (signal start)

Voltage is applied to the coil at all times. When a start signal is supplied, the relay contacts transfer immediately to the **on state** and the set time begins. When the set time has elapsed, the relay contacts transfer to the **off state**. The contacts remain in the **off state** until the timer is reset. The timer is reset by applying a reset input or by removing the coil voltage. Applicable models: GT3A-5 and GT3D-4.

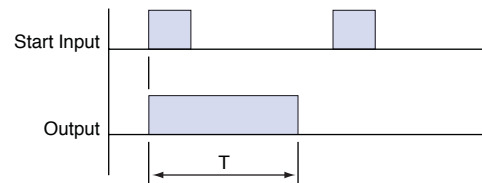

Type No.	GT3A-5	GT3D-4
Mode	A	2-E
See Page	805	813



1. T = set time, T' = shorter than set time, Ts = one shot output time
2. For more detailed timing diagrams, see specifications for individual timer models.

### Cycle 1 (power start, OFF first)

When voltage is applied to the coil, the contacts remain in the **off state** and the set time begins. At the end of the set time, the contacts transfer to the **on state** and remain in the **on state** until the set time elapses. The timer cycles between the two states until power is removed from the coil. Removing the coil voltage resets the timer. The set time for both the **on state** and the **off state** is the same. Applicable models: GT3A-1, -2, -3, GT3D-1, -2, -3, -4 and RTE-P(B)1.

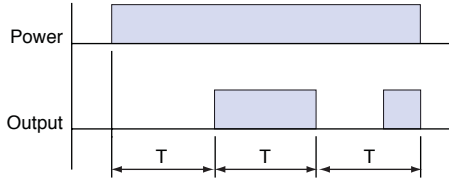

Type No.	GT3A-1, -2, -3	GT3D-1, -2, -3, -4	RTE-*1
Mode	C	1-C	C
See Page	805	813	798

### Cycle 3 (power start, ON first)

When voltage is applied to the coil, the contacts immediately transfer to the **on state** and the set time begins. At the end of the set time, the contacts transfer to the **off state** and remain in the **off state** until the set time elapses. The timer cycles between the two states until power is removed from the coil. Removing the coil voltage resets the timer. The set time for both the **off state** and the **on state** is the same. Applicable models: GT3A-1, -2, -3, GT3D-1, -2, -3, -4 and RTE-P(B)1.

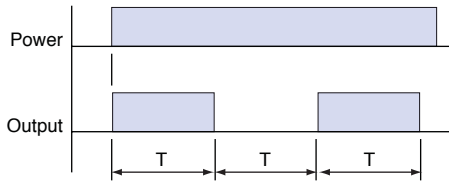

Type No.	GT3A-1, -2, -3	GT3D-1, -2, -3, -4	RTE-*1
Mode	D	1-D	D
See Page	805	813	798

### One Shot 1 (signal start, retriggerable)

Voltage is applied to the coil at all times. When a start signal is supplied, the contacts immediately transfer to the **on state** and the set time begins. If another start signal is supplied (**before set time has elapsed**) the set time restarts, as the contacts remain in the **on state**. Successive pulses at a frequency greater than the set time will cause the contacts to remain in the **"On state"** indefinitely. When the set time has elapsed the contacts transfer back to the **off state**. The contacts remain in the **off state** until the next start signal is supplied (no reset is necessary). The timer can be reset by application of a reset input or by removing coil voltage. Applicable models: GT3A-6 and GT3D-4.

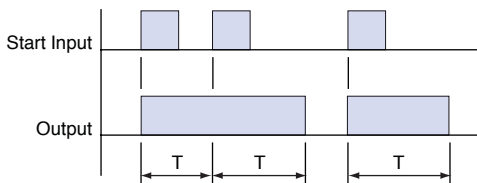

Type No.	GT3A-6	GT3D-4
Mode	A	3-C
See Page	805	813

### Cycle 2 (signal start, OFF first)

Voltage is applied to the coil at all times. When a start signal is supplied, the relay contacts remain in the **off state** and the set time begins. At the end of the set time, the contacts transfer to the **on state** and remain in the **on state** until the set time elapses. The timer cycles between the two states until the timer is reset. The set time for both the **on state** and the **off state** are the same. The timer is reset by application of a reset input or by removing coil voltage. Applicable models: GT3A-4, GT3D-4 and RTE-P(B) 2.

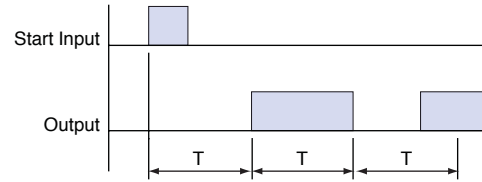

Type No.	GT3A-4	GT3D-4	RTE-*2
Mode	B	2-B	B
See Page	805	813	798

### One Shot Cycle (signal start)

Voltage is applied to the coil at all times. When a start signal is supplied, the contacts remain in the **off state** and the set time begins. At the end of the set time, the contacts transfer to the **on state** and remain in the **on state** for the set time. After the set time has elapsed, the contacts return to the **off state**. The contacts remain in the **off state** until the timer is reset. The timer is reset by application of a reset input or by removing coil voltage. Applicable models: GT3A-5 and GT3D-4.

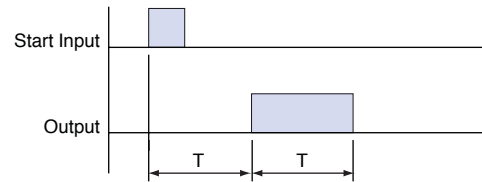

Type No.	GT3A-5	GT3D-4
Mode	B	2-F
See Page	805	813

### One Shot 2 (signal start)

Voltage is applied to the coil at all times. When a start signal is supplied, the contacts immediately transfer to the **on state** and the set time begins. If another start signal is supplied (**before set time has elapsed**), the set time will not be affected. When the set time has elapsed, the contacts transfer back to the **off state**. The contacts remain in the **off state** until the next start signal is supplied (no reset is necessary). The timer can be reset by application of a reset input or by removing coil voltage. Applicable models: GT3A-6, GT3D-4, and RTE-P(B)2.

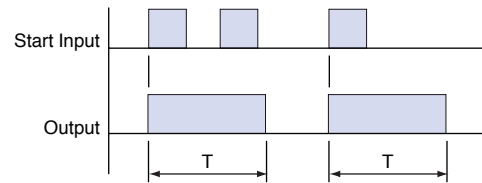

Type No.	GT3A-6	GT3D-4	RTE-*2
Mode	C	3-E	F
See Page	805	813	798

1. T = set time, T' = shorter than set time, Ts = one shot output time  
 2. For more detailed timing diagrams, see specifications for individual timer models.

### Signal ON/OFF-Delay 1

Voltage is supplied to the coil at all times. When a maintained start signal is supplied, the contacts immediately transfer to the **on state** and the set time begins. When the set time has elapsed, the contacts transfer to the **off state**. The contacts remain in the **off state** until the start signal is removed. The contacts transfer back to the **on state** and remain in the **on state** for the set time. When the set time has elapsed, the contacts transfer to the **off state** and remain in the **off state** until the start signal is supplied again (no reset is necessary). The timer is reset by application of a reset input or by removing coil voltage. Applicable models: GT3A-4, GT3D-4 and RTE-R(B)2.

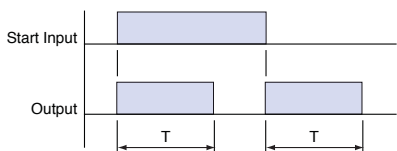

Type No.	GT3A-4	GT3D-4	RTE-*2
Mode	C	2-C	D
See Page	805	813	798

### Signal ON/OFF-Delay 2

Voltage is supplied to the coil at all times. When a maintained start signal is supplied, the contacts remain in the **off state** and the set time begins. When the set time has elapsed, the contacts transfer to the **on state**. The contacts remain in the **on state** until the start signal is removed. Once the start signal is removed, the contacts remain in the **on state** and the set time begins again. Once the set time has elapsed, the contacts transfer back to the **off state**. The timer is ready for the next start signal. The timer is reset by the application of a reset signal or removal of power. Applicable models: GT3A-5 and GT3D-4.

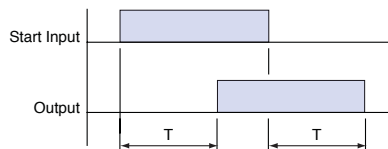

Type No.	GT3A-5	GT3D-4
Mode	C	3-A
See Page	805	813

### Signal OFF-Delay 1

Voltage is applied to the coil at all times. When a start signal is supplied, the contacts immediately transfer to the **on state**. The set time begins **when the start signal is removed**. When the set time has elapsed, the contacts transfer to the **off state**. The contacts remain in the **off state** until the next start signal is supplied (no reset is necessary). The timer can be reset by application of a reset input or by removing coil voltage. Applicable models: RTE-P(B)2, GT3A-4, and GT3D-4.

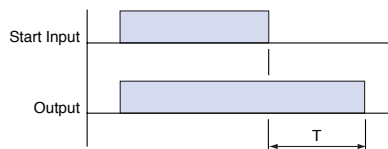

Type No.	GT3A-4	GT3D-4	RTE-*2
Mode	D	2-D	E
See Page	805	813	798

### Signal OFF-Delay 2

Voltage is applied to the coil at all times. When a maintained start signal is supplied, the contacts remain in the **off state**. When the "start signal is removed", the contacts transfer to the **On state** and the set time begins. When the set time has elapsed, the contacts transfer back to the **off state**. They remain in the **off state** until the next start signal is supplied (no reset is necessary). The timer can be reset by application of a reset input or by removing coil voltage. Applicable models: GT3A-5 and GT3D-4.

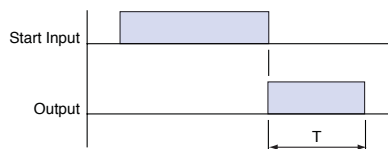

Type No.	GT3A-5	GT3D-4
Mode	D	3-B
See Page	805	813

Voltage is supplied to the coil at all times. When a momentary start signal is supplied, the contacts remain in the **off state** and the set time begins. When the set time has elapsed, the contacts transfer to the **on state**. The contacts remain in the **on state** until another momentary input is supplied. The contacts then remain in the **on state** for the set time. When the set time has elapsed, the contacts transfer to the **off state** and remain in the **off state** until the start signal is supplied again (no reset is necessary). The timer is reset by application of a reset input or by removing coil voltage. Applicable models: GT3A-6 and GT3D-4.

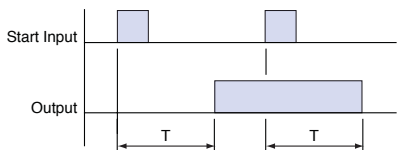

Type No.	GT3A-6	GT3D-4
Mode	D	3-F
See Page	805	813

### One Shot ON-Delay (signal start)

When voltage is applied to the coil, the preset time is initiated and the contacts remain in the **off state** for the preset time. Following the preset time, the contacts transfer to the **on state**, and remain in the **on state** until the start input is supplied. Following the start input, the contacts transfer to the **off state** for the preset time. After the preset time has elapsed, the contacts transfer back to the **on state** and remain there until either the next start input is supplied or the timer is reset. The timer can be reset by either a reset input or removal of the coil voltage. Applicable models: GT3A-6 and GT3D-4.

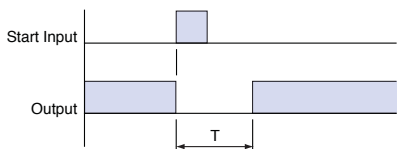

Type No.	GT3A-6	GT3D-4
Mode	B	3-D
See Page	805	813

1. T = set time, T' = shorter than set time, Ts = one shot output time  
 2. For more detailed timing diagrams, see specifications for individual timer models.

**ON-Delay One-Shot Output 1 (signal start)**

Voltage is applied to the coil at all times. When a momentary start signal is supplied, the contacts remain in the off state and the preset time begins. Following the preset time, the contacts transfer to the on state and remain in the on state for the one-shot preset time. Following the one-shot preset time, the contacts transfer back to the off state and remain there until the timer is reset. The timer can be reset by applying either a reset input or removal of the coil voltage. Applicable model: GT3D-8.

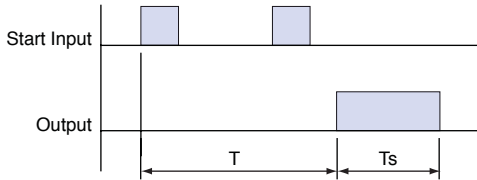

Type No.	GT3D-8
Mode	1
See Page	813

**ON-Delay One-Shot Output 2 (signal start)**

Voltage is applied to the coil at all times. When a maintained start signal is supplied, the contacts remain in the **off state** and the preset time begins. Following the preset time (start input is still present), the contacts transfer to the **on state** and remain in the **on state** for the one-shot preset time. When the one-shot preset time has elapsed, contacts transfer back to the **off state** and remain there until timer is reset. The timer can be reset by a reset input, removal of the coil voltage or removal of start input. Applicable model: GT3D-8.

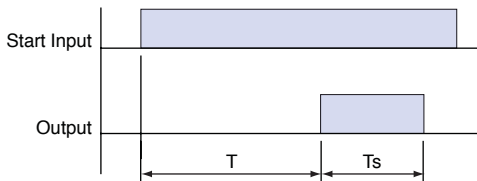

Type No.	GT3D-8
Mode	3
See Page	813

**Sequential Start (power start)**

When voltage is applied to the coil, both contacts remain in the OFF state and the set time, T1, begins. When T1 has elapsed, output 1 comes on and T2 begins. When T2 has elapsed, output 2 comes on. Both outputs remain on until power is removed from the coil. Applicable model: GT3W-A.

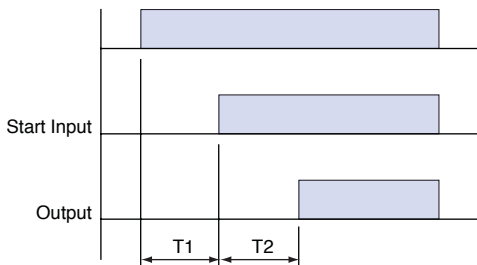

Type No.	GT3W-A
Mode	A
See Page	834

**Cycle One-Shot Output (signal start)**

Voltage is applied to the coil at all times. When a momentary start signal is supplied, the contacts remain in the **off state** and the preset time begins. Following the preset time, the contacts transfer to the **on state**. The contacts remain in the **on state** for the one-shot preset time. After the one-shot preset time has elapsed, the contacts transfer back to the **off state**. The contacts remain in the **off state** for the preset time minus the one-shot preset time. The timer cycles between **on and off states** until the timer is reset by a reset input or removal of the coil voltage. Applicable model: GT3D-8.

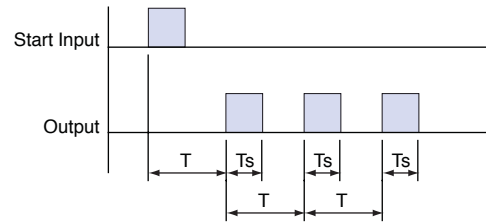

Type No.	GT3D-8
Mode	2
See Page	813

**True Power-OFF Delay**

When voltage is applied, output comes on immediately; when voltage is removed from the coil, the timer begins timing (internal capacitors power the timing circuit). When time has expired, contacts transfer back to the OFF state. If power is reapplied before the elapsed time has expired, the timing function will reset back to the starting point. Applicable models: GT3F-1, 2.

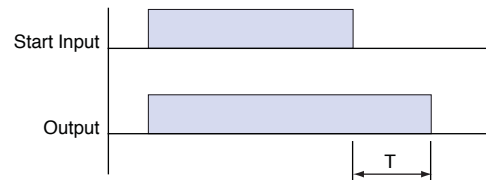

Type No.	GT3F-1, 2
Mode	Power OFF-Delay
See Page	826

**Recycler Outputs (power start)**

When voltage is applied to the coil, both contacts remain in the off state and time T1 begins. When T1 has elapsed, both contacts transfer to the ON state and T2 begins. When T2 has elapsed, both contacts transfer back to the OFF state and T1 begins again. The cycle continues until power is removed, at which time both contacts transfer back to the OFF state. Applicable model: GT3W-A.

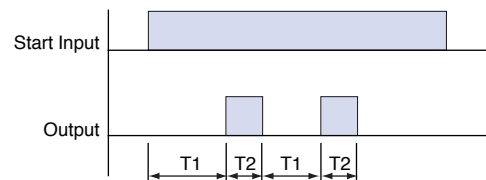

Type No.	GT3W-A
Mode	D
See Page	834

1. T = set time, T' = shorter than set time, Ts = one shot output time  
 2. For more detailed timing diagrams, see specifications for individual timer models.



**RTE Series – Analog Timers**

**Key features of the RTE series include:**

- 20 time ranges and 10 timing functions
- Time delays up to 600 hours
- Space-saving package
- High repeat accuracy of ± 0.2%
- ON and timing OUT LED indicators
- Standard 8- or 11-pin and 11-blade termination
- 2 form C delayed output contacts
- 10A Contact Rating



Cert. No. E9950913332316 (EMC, RTE)  
Cert. No. BL960813332355 (LVD, RTE)



UL Listed  
File No. E66043



**General Specifications**

<b>Operation System</b>		Solid state CMOS Circuit	
<b>Operation Type</b>		Multi-Mode	
<b>Time Range</b>		0.1sec to 600 hours	
<b>Pollution Degree</b>		2 (IE60664-1)	
<b>Over voltage category</b>		III (IE60664-1)	
<b>Rated Operational Voltage</b>	AF20	100-240V AC(50/60Hz)	
	AD24	24V AC(50/60Hz)/24V DC	
	D12	12V DC	
<b>Voltage Tolerance</b>	AF20	85-264V AC(50/60Hz)	
	AD24	20.4-26.4V AC(50/60Hz)/21.6-26.4V DC	
	D12	10.8-13.2V DC	
<b>Input off Voltage</b>		Rated Voltage x10% minimum	
<b>Ambient Operating Temperature</b>		-20 to +65°C (without freezing)	
<b>Ambient Storage and Transport Temperature</b>		-30 to +75°C (without freezing)	
<b>Relative Humidity</b>		35 to 85%RH (without condensation)	
<b>Atmospheric Pressure</b>		80kPa to 110kPa (Operating), 70kPa to 110kPa (Transport)	
<b>Reset Time</b>		100msec maximum	
<b>Repeat Error</b>		±0.2%, ±20msec*	
<b>Voltage Error</b>		±0.2%, ±20msec*	
<b>Temperature Error</b>		±0.5%, ±20msec*	
<b>Setting Error</b>		±10% maximum	
<b>Insulation Resistance</b>		100MΩ minimum (500V DC)	
<b>Dielectric Strength</b>		Between power and output terminals: 2000V AC, 1 minute	
		Between contacts of different poles: 2000V AC, 1 minute	
		Between contacts of the same pole:1000V AC, 1 minute	
<b>Vibration Resistance</b>		10 to 55Hz amplitude 0.5mm <sup>2</sup> hours in each of 3 axes	
<b>Shock Resistance</b>		Operating extremes: 98m/sec <sup>2</sup> (10G) Damage limits: 490m/sec <sup>2</sup> (50G) 3 times in each of 3 axes	
<b>Degree of Protection</b>		IP40 (enclosure) (IEC60529)	
<b>Power Consumption (Approx.)</b>	TYPE	RTE-P1, -B1	RTE-P2, -B2
		AF20	
	120V AC/60Hz	6.5VA	6.6VA
	240V AC/60Hz	11.6VA	11.6VA
24V AC 60Hz/DC	3.4VA/1.7W	3.5VA/1.7W	
D12	1.6W	1.6W	
<b>Mounting Position</b>		Free	
<b>Dimensions</b>	RTE-P1, P2	40Hx 36W x 77.9D mm	
	RTE-B1, B2	40Hx 36W x 74.9D mm	
<b>Weight (Approx.)</b>	RTE-P1	RTE-P2	RTE-B1, -B2
	87g	89g	85g

**Contact Ratings**

<b>Contact Configuration</b>	2 Form C, DPDT (Delay output)	
<b>Allowable Voltage / Allowable Current</b>	240V AC, 30V DC / 10A	
<b>Maximum Permissible Operating Frequency</b>	1800 cycles per hour	
<b>Rated Load</b>	Resistive	10A 240V AC, 30V DC
	Inductive	7A 240V AC, 30V DC
	Horse Power Rating	1/6 HP 120V AC, 1/3 HP 240V AC
<b>Life</b>	Electrical	500,000 op. minimum (Resistive)
	Mechanical	50,000,000 op. minimum



\*For the value of the error against a preset time, whichever the largest. applies.

Switches & Pilot Lights

Display Lights

Relays & Sockets

Timers

Terminal Blocks

Circuit Breakers



## Part Numbering Guide

RTE series part numbers are composed of 4 part number codes. When ordering a RTE series part, select one code from each category.  
Example: **RTE-P1AF20**

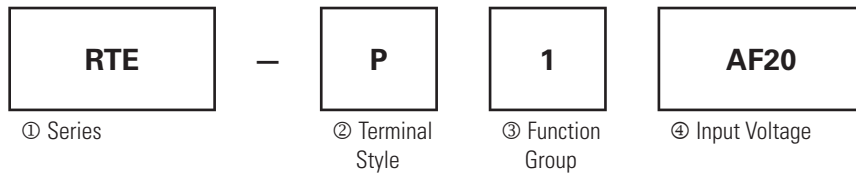

### Part Numbers: RTE Series

	Description	Part Number Code	Remarks
① Series	RTE series	RTE	For internal circuits, see next page.
② Terminal Style	Pin	P	Select one only.
	Blade	B	
③ Function Group	ON-delay, interval, cycle OFF, cycle ON	1	Each function group has different timing functions.
	ON-delay, cycle OFF, cycle ON, signal ON/OFF delay, OFF-delay, one-shot	2	See page 794.
④ Input Voltage	100 to 240V AC(50/60Hz)	AF20	
	24V AC(50/60Hz)/24V DC	AD24	
	12V DC	D12	

### Part Numbers

Voltage	Power Triggered		Start Input Triggered	
	8-Pin	Blade	11-Pin	Blade
12V DC	RTE-P1D12	RTE-B1D12	RTE-P2D12	RTE-B2D12
24V AC/DC	RTE-P1AD24	RTE-B1AD24	RTE-P2AD24	RTE-B2AD24
100-240V AC	RTE-P1AF20	RTE-B1AF20	RTE-P2AF20	RTE-B2AF20

### Time Range Determined by Time Range Selector and Dial Selector

	Dial	0 - 1	0 - 3	0 - 10	0 - 30	0 - 60
Range	Second	0.1 sec - 1 sec	0.1 sec - 3 sec	0.2 sec - 10 sec	0.6 sec - 30 sec	1.2 sec - 60 sec
	Minute	1.2 sec - 1 min	3.6 sec - 3 min	12 sec - 10 min	36 sec - 30 min	1.2 min - 60 min
	Hour	1.2 min - 1 hr	3.6 min - 3 hr	12 min - 10 hr	36 min - 30 hr	1.2 hr - 60 hr
	10 Hours	12 min - 10 hr	36 min - 30 hr	2 hr - 100 hr	6 hr - 300 hr	12 hr - 600 hr

Timing Diagrams

RTE-P1, -B1



1. RTE-B1: Do not apply voltage to terminals #2, #5 & #8.
2. IDEC sockets are as follows: RTE-P1: SR2P-06\* pin type socket, RTE-B1: SR3B-05\* blade type socket, (\*-may be followed by suffix letter A,B,C or U).

RTE-P1

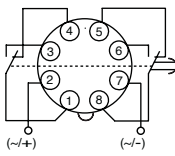

RTE-B1

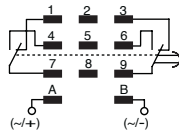

A: ON-Delay 1 (power start)

Set timer for desired delay, apply power to coil. Contacts transfer after preset time has elapsed, and remain in transferred position until timer is reset. Reset occurs with removal of power.

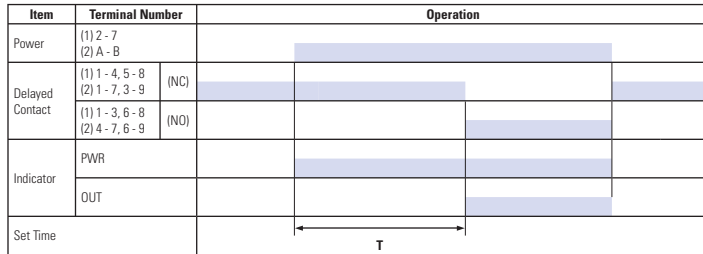

B: Interval (power start)

Set timer for desired delay, apply power to coil. Contacts transfer immediately, and return to original position after preset time has elapsed. Reset occurs with removal of power.

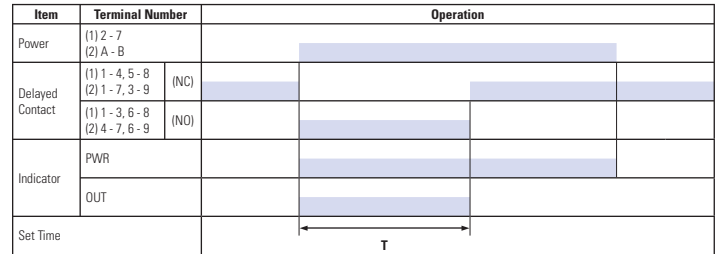

C: Cycle 1 (power start, OFF first)

Set timer for desired delay, apply power to coil. First transfer of contacts occurs after preset delay has elapsed, after the next elapse of preset delay contacts return to original position. The timer now cycles between on and off as long as power is applied (duty ratio 1:1).

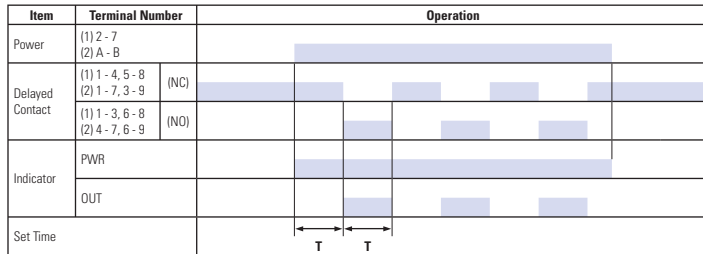

C: Cycle 3 (power start, ON first)

Functions in same manner as Mode C, with the exception that first transfer of contacts occurs as soon as power is applied. The ratio is 1:1. Time On = Time Off

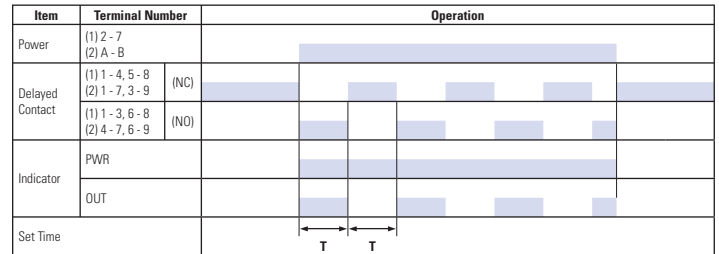

## Timing Diagrams con't

### RTE-P2, -B2

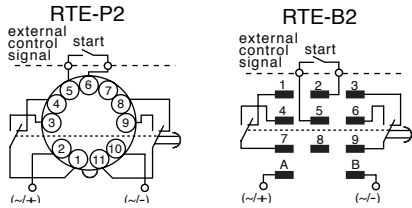

1. RTE-P2: Do not apply voltage to terminals #5, #6 & #7.
2. RTE-B2: Do not apply voltage to terminals #2, #5 & #8.
3. IDEC sockets are as follows: RTE-P2: SR3P-05\* pin type socket, RTE-B2: SR3B-05\* blade type socket, (\*-may be followed by suffix letter A,B,C or U).

#### A: ON-Delay 2 (signal start)

When a preset time has elapsed after the start input turned on while power is on, the NO output contact goes on.

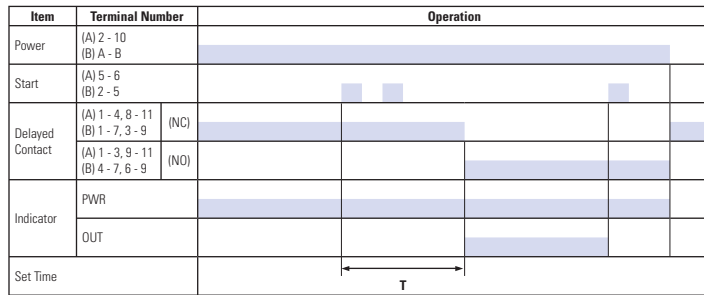

#### B: Cycle 2 (signal start, OFF first)

When the start input turns on while power is on, the output oscillates at a preset cycle (duty ratio 1:1), starting while the NO contact off.

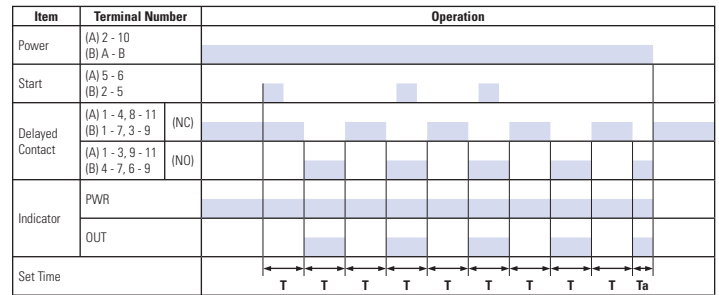

#### C: Cycle 4 (signal start, ON first)

When the start input turns on while power is on, the NO contact goes on. The output oscillates at a preset cycle (duty ratio 1:1).

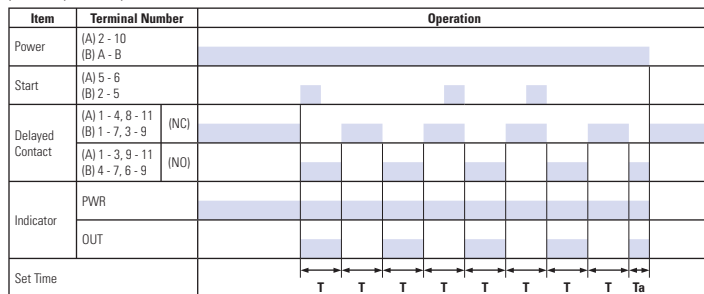

#### D: Signal ON/OFF-Delay

When the start input turns on while power is on, the NO output contact goes on. When a preset time has elapsed while the start input remains on, the output contact goes off. When the start input turns off, the NO contact goes on again. When a preset time has elapsed after the start input turned off, the NO contact goes off.

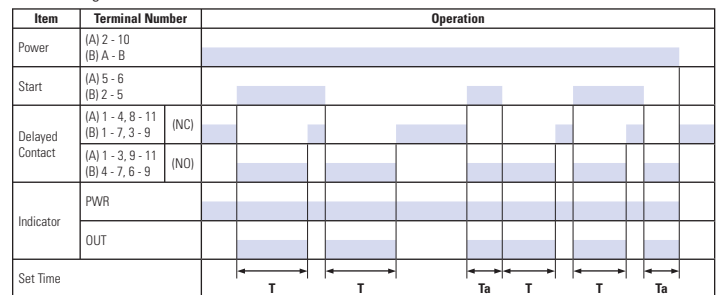

#### E: Signal OFF-Delay

When power is turned on while the start input is on, the NO output contact goes on. When a preset time has elapsed after the start input turned off, the NO output contact goes off.

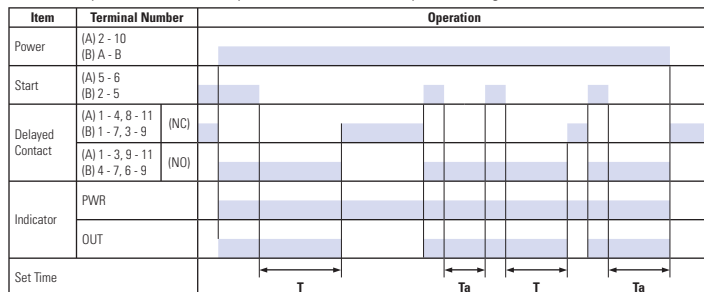

#### F: One-Shot (signal start)

When the start input turns on while power is on, the NO output contact goes on. When a preset time has elapsed, the NO output contact goes off.

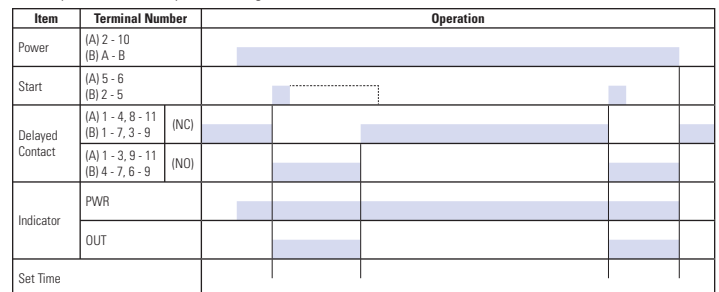

### Temperature Derating Curves

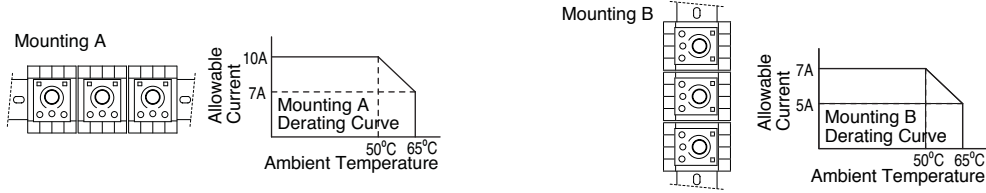

### Instructions

#### Installation of Hold-Down Springs DIN Rail Mount Socket

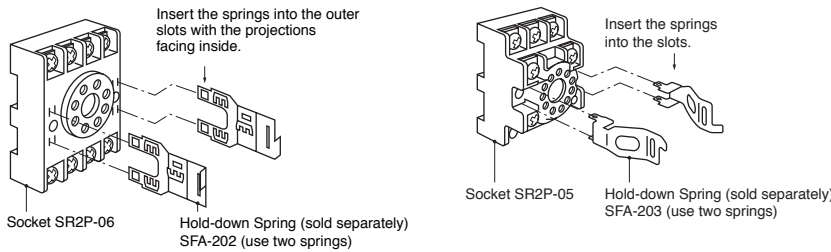

#### Switch Settings

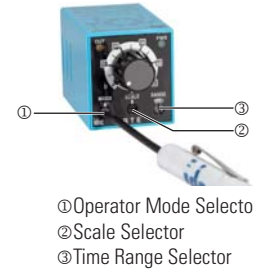

1. Turn the selectors securely using a flat screwdriver 4mm wide (maximum). Note that incorrect setting may cause malfunction. Do not turn the selectors beyond their limits.
2. Since changing the setting during timer operation may cause malfunction, turn power off before changing.

### Safety Precautions

Special expertise is required to use Electronic Timers.

- All Electronic Timers are manufactured under IDEC's rigorous quality control system, but users must add a backup or fail safe provision to the control system when using the Electronic Timer in applications where heavy damage or personal injury may occur should the Electronic Timer fail.
- Install the Electronic Timer according to instructions described in this catalog.
- Make sure that the operating conditions are as described in the specifications. If you are uncertain about the specifications, contact IDEC in advance.
- In these directions, safety precautions are categorized in order of importance under Warning and Caution.

#### Warnings

Warning notices are used to emphasize that improper operation may cause severe personal injury or death.

- Turn power off to the Electronic timer before starting installation, removal, wiring, maintenance, and inspection on the Electronic Timer.
- Failure to turn power off may cause electrical shocks or fire hazard.

- Do not use the Electronic Timer for an **emergency stop circuit** or **interlocking circuit**. If the Electronic Timer should fail, a machine malfunction, breakdown, or accident may occur.

#### Caution

Caution notices are used where inattention might cause personal injury or damage to equipment.

- The Electronic Timer is designed for installation in equipment. Do not install the Electronic Timer outside equipment.
- Install the Electronic Timer in environments described in the specifications. If the Electronic Timer is used in places where it will be subjected to high-temperature, high-humidity, condensation, corrosive gases, excessive vibrations, or excessive shocks, then electrical shocks, fire hazard, or malfunction could result.
- Use an IEC60127-approved fuse and circuit breaker on the power and output line outside the Electronic Timer.
- Do not disassemble, repair, or modify the Electronic Timer.
- When disposing of the Electronic Timer, do so as industrial waste.

Accessories

DIN Rail Mounting Accessories

DIN Rail/Surface Mount Sockets and Hold-Down Springs

DIN Rail Mount Socket				Applicable Hold-Down Springs	
Style	Appearance	Use with Timers	Part Number	Appearance	Part Number
11-Pin Screw Terminal (dual tier)		RTE-P2	SR3P-05		SFA-203
11-Pin FingerSafe Socket		RTE-P2	SR3P-05C		
8-Pin Screw Terminal		RTE-P1	SR2P-06		SFA-202
8-Pin Fingersafe Socket			SR2P-05C		
11-Blade Screw Terminal		RTE-B1 RTE-B2	SR3B-05		
DIN Mounting Rail Length 1000mm		—	BNDN1000		

Switches & Pilot Lights

Display Lights

Relays & Sockets

Timers

Terminal Blocks

Circuit Breakers

Panel Mounting Accessories

Flush Panel Mount Adapter and Sockets that use an Adapter

Accessory	Description	Appearance	Use with	Part No.
<b>Panel Mount Adapter</b>	Adaptor for flush panel mounting RTE timers		All RTE timers	RTB-G01
<b>Sockets for use with Panel Mount Adapter</b>	8-pin screw terminal		RTE-P1	SR6P-M08G
	11-pin screw terminal		RTE-P2	SR6P-M11G
	8-pin solder terminal		RTE-P1	SR6P-S08
	11-pin solder terminal		RTE-P2	SR6P-S11

Dimensions

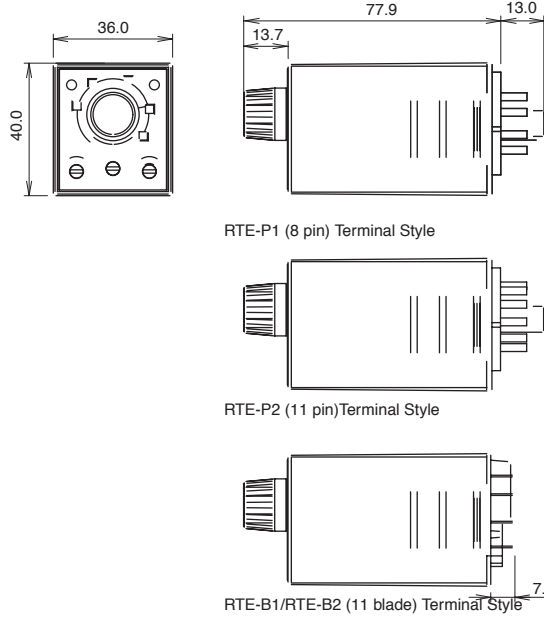

Panel Mount Adapter

RTE Timer, 8-Pin and 11-Pin with SR6P-S08 or SR6P-S11

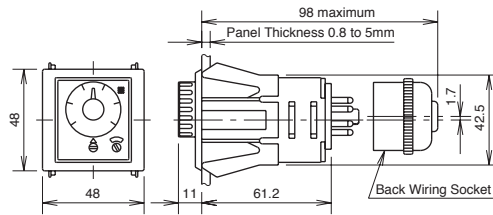

RTE Timer, 8-Pin with SR6P-M08G

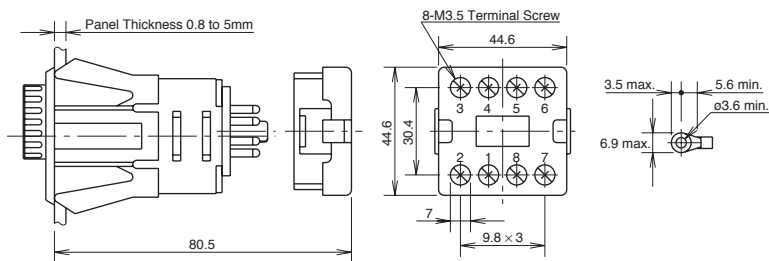

RTE Timer, 11-Pin with SR6P-M11G

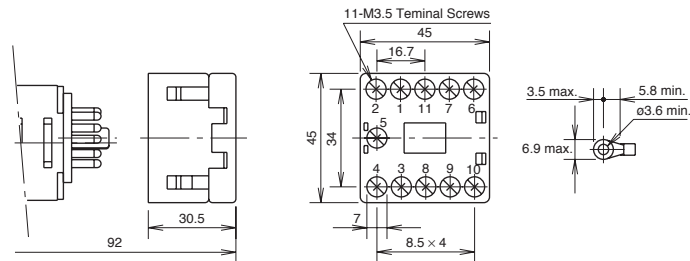

## GT3A Series – Analog Timers

### Key features of the GT3A series include:

- 4 selectable operation modes on each model
- External start, reset, and pause inputs
- Panel mount or socket mount
- Large variety of timing functions
- Power and output status indicating LEDs



### Specifications

	GT3A-1	GT3A-2	GT3A-3	GT3A-4,-5,-6
<b>Operation</b>	Multi-mode			Multi-mode with inputs (11 pins)
<b>Time Range</b>	0.1s to 180 hours			
<b>Rated Voltage</b>	100 to 240V AC, 50/60Hz 12V DC 24V AC, 50/60Hz / 24V DC			
<b>Contact Ratings</b>	125V AC/250V AC, 3A; 30V DC, 1A (resistive load)		125V AC/250V AC, 5A; 30V DC, 5A (resistive load)	
<b>Minimum Applicable Load</b>	5V, 10mA (reference value)			
<b>Voltage Tolerance</b>	AF20 (100V AC): 85 to 264V AC AD24: 20.4 to 26.4V AC/21.6 to 26.4V DC D12: 10.8 to 13.2V DC			
<b>Error</b>	±0.2%, ±10 msec (repeat, voltage, temperature)			
<b>Setting Error</b>	±10% maximum			
<b>Reset Time</b>	60msec maximum			
<b>Insulation Resistance</b>	100MW minimum			
<b>Dielectric Strength</b>	Between power and output terminals: 2,000V AC, 1 minute Between contacts of different poles: 2,000V AC, 1 minute Between contacts of the same pole: 750V AC, 1 minute			
<b>Power Consumption (approximate)</b>	Delayed SPDT	Delayed SPDT + instantaneous SPDT	Delayed DPDT	Delayed DPDT
	10.8VA (200V AC, 60Hz)	13.5VA (200V AC, 60Hz)	14.4VA (200V AC, 60Hz)	4.7VA (100V AC, 60Hz), 14.4VA (200V AC, 60Hz)
	—	12VDC/1W 24VDC/0.7W 24VAC/1.2VA	12VDC/1.1W 24VDC/0.6W 24VAC/1.3VA	12VDC/0.8W 24VDC/0.6W 24VAC/1.3VA
<b>Mechanical Life</b>	10,000,000 operations minimum		5,000,000 operations minimum	
<b>Electrical Life</b>	50,000 operations minimum (rated load)		100,000 operations minimum (rated load)	
<b>Weight (approximate)</b>	63g	73g	79g	80g
<b>Vibration Resistance</b>	100m/sec <sup>2</sup> (approximate 10G)			
<b>Shock Resistance</b>	Operating extremes: 100m/sec <sup>2</sup> (approximate 10G) Damage limits: 500m/sec <sup>2</sup> (approximate 50G)			
<b>Operating Temperature</b>	-10 to +50°C			
<b>Operating Humidity</b>	45 to 85% RH			
<b>Storage Temperature</b>	-30 to +80°C			
<b>Housing Color</b>	Gray			



**Part Numbers**
**GT3A-1, -2, -3**

Mode Of Operation	Rated Voltage Code	Time Range	Output	Contact	Complete Part No.	
					8-Pin	11-Pin
A: ON-delay 1 B: Interval 1 C: Cycle 1 D: Cycle 3	AF20: 100 to 240V AC (50/60Hz)	0.1 seconds to 180 hours	250V AC, 3A, 30V DC, 1A (resistive load)	Delayed SPDT	GT3A-1AF20	GT3A-1EAF20
	AF20: 100 to 240V AC (50/60Hz) D12: 12V DC AD24: 24V AC (50/60Hz)/24V DC				Delayed SPDT + Instantaneous SPDT	GT3A-2AF20
				Delayed DPDT		GT3A-2D12
					Delayed DPDT	GT3A-2AD24
				Delayed DPDT		GT3A-3AF20
	Delayed DPDT				GT3A-3D12	GT3A-3ED12
Delayed DPDT		GT3A-3AD24	GT3A-3EAD24			

- 
1. For wiring schematics and timing diagrams for GT3A-1, -2, -3, see pages 807 and 808 respectively.
  2. For more details about time ranges, see instructions on page 812.
  3. For socket and accessory part numbers, see page 838.

**GT3A-4, -5, -6**

Mode of Operation	Rated Voltage Code	Time Range	Output	Contact	Input	Complete Part No.	
						A (11-pin)	B (11-pin)
A: ON-Delay 2 B: Cycle 2 C: Signal ON/OFF-Delay 1 D: Signal OFF-Delay 1	AF20: 100 to 240V AC (50/60Hz) D12: 12V DC AD24: 24V AC (50/60Hz)/24V DC	0.1 seconds to 180 hours	250V AC, 5A, 24V DC, 5A (resistive load)	Delayed DPDT	Start Reset Gate	GT3A-4AF20	GT3A-4EAF20
						GT3A-4D12	GT3A-4ED12
						GT3A-4AD24	GT3A-4EAD24
A: Interval 2 B: One-Shot Cycle C: Signal ON/OFF-Delay 2 D: Signal OFF-Delay 2	AF20: 100 to 240V AC (50/60Hz) AD24: 24V AC (50/60Hz)/24V DC	0.1 seconds to 180 hours	250V AC, 5A, 24V DC, 5A (resistive load)	Delayed DPDT	Start Reset Gate	GT3A-5AF20	GT3A-5EAF20
						GT3A-5AD24	GT3A-5EAD24
A: One-Shot B: One-Shot ON-Delay C: One-Shot 2 D: Signal ON/OFF-Delay 3	AF20: 100 to 240V AC (50/60Hz) AD24: 24V AC (50/60Hz)/24V DC	0.1 seconds to 180 hours	250V AC, 5A, 24V DC, 5A (resistive load)	Delayed DPDT	Start Reset Gate	GT3A-6AF20	GT3A-6EAF20
						GT3A-6AD24	GT3A-6EAD24

- 
4. For wiring schematics and timing diagrams GT3A-4,-5,-6, see pages 809, 810, and 811 respectively.
  5. For more details about time ranges, see instructions on page 812.
  6. A (11-pin) and B (11-pin) differ in the way inputs are wired.
  7. For socket and accessory part numbers, see page 838.
  8. For the timing diagrams overview, see page 794.

Switches &amp; Pilot Lights

Display Lights

Relays &amp; Sockets

Timers

Terminal Blocks

Circuit Breakers

Timing Diagrams/Schematics

GT3A-1 Timing Diagrams  
Delayed SPDT

Operation  
Mode  
Selection

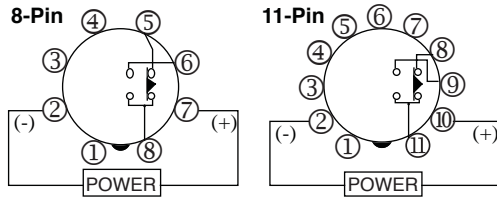

ON-Delay 1

MODE



Item	Terminal Number	Operation
Set Time		$T$
Power	2 - 7 (8p) 2 - 10 (11p)	[Timing diagram showing power pulse]
Delayed Contact	5 - 8 (8p) (NC)	[Timing diagram showing NC contact pulse]
	8 - 11 (11p) (NC)	[Timing diagram showing NC contact pulse]
	6 - 8 (8p) (NO) 9 - 11 (11p) (NO)	[Timing diagram showing NO contact pulse]
Indicator	POWER	[Timing diagram showing power indicator pulse]
	OUT	[Timing diagram showing output pulse]

Interval 1

MODE



Item	Terminal Number	Operation
Set Time		$T$
Power	2 - 7 (8p) 2 - 10 (11p)	[Timing diagram showing power pulse]
Delayed Contact	5 - 8 (8p) (NC)	[Timing diagram showing NC contact pulse]
	8 - 11 (11p) (NC)	[Timing diagram showing NC contact pulse]
	6 - 8 (8p) (NO) 9 - 11 (11p) (NO)	[Timing diagram showing NO contact pulse]
Indicator	POWER	[Timing diagram showing power indicator pulse]
	OUT	[Timing diagram showing output pulse]

Cycle 1

(OFF first)

MODE



Item	Terminal Number	Operation
Set Time		$T$ $T$
Power	2 - 7 (8p) 2 - 10 (11p)	[Timing diagram showing power pulse]
Delayed Contact	5 - 8 (8p) (NC)	[Timing diagram showing NC contact pulse]
	8 - 11 (11p) (NC)	[Timing diagram showing NC contact pulse]
	6 - 8 (8p) (NO) 9 - 11 (11p) (NO)	[Timing diagram showing NO contact pulse]
Indicator	POWER	[Timing diagram showing power indicator pulse]
	OUT	[Timing diagram showing output pulse]

Cycle 3

(ON first)

MODE



Item	Terminal Number	Operation
Set Time		$T$ $T$
Power	2 - 7 (8p) 2 - 10 (11p)	[Timing diagram showing power pulse]
Delayed Contact	5 - 8 (8p) (NC)	[Timing diagram showing NC contact pulse]
	8 - 11 (11p) (NC)	[Timing diagram showing NC contact pulse]
	6 - 8 (8p) (NO) 9 - 11 (11p) (NO)	[Timing diagram showing NO contact pulse]
Indicator	POWER	[Timing diagram showing power indicator pulse]
	OUT	[Timing diagram showing output pulse]

**GT3A-2 Timing Diagrams**  
**Delayed SPDT + Instantaneous SPDT**

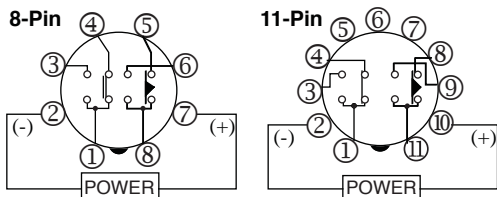

Operation Mode Selection

**ON-Delay 1**

MODE

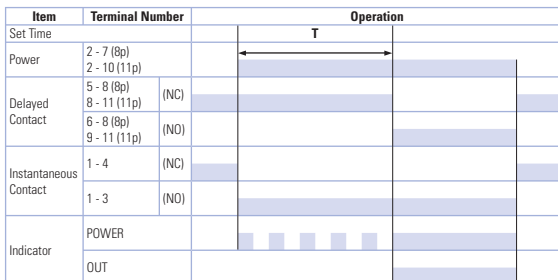

**Interval 1**

MODE

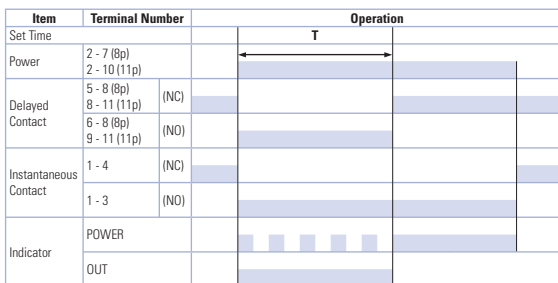

**Cycle 1 (OFF first)**

MODE

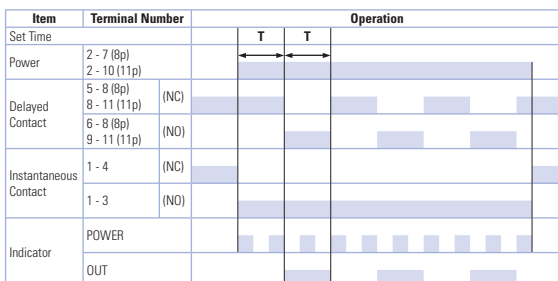

**GT3A-3 Timing Diagrams**  
**Delayed DPDT**

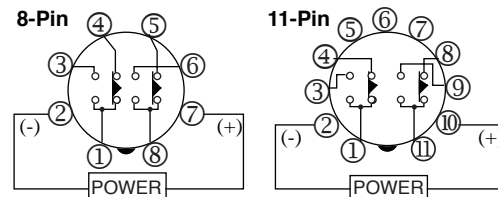

Operation Mode Selection

**ON-Delay 1**

MODE

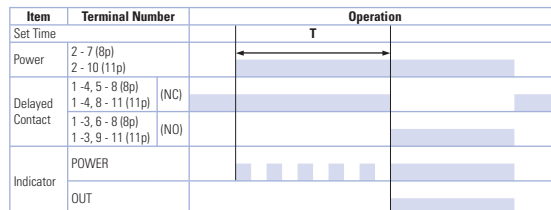

**Interval 1**

MODE

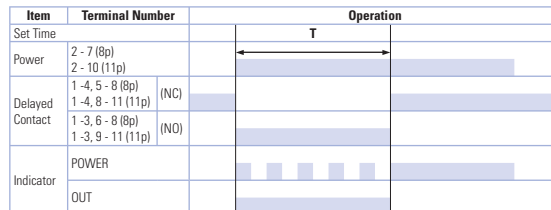

**Cycle 1 (OFF first)**

MODE

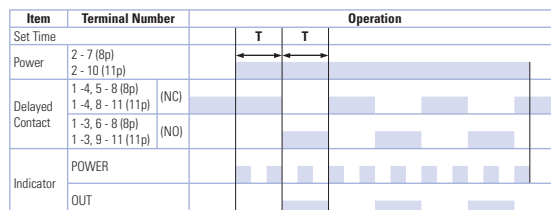

**Cycle 3 (ON first)**

MODE

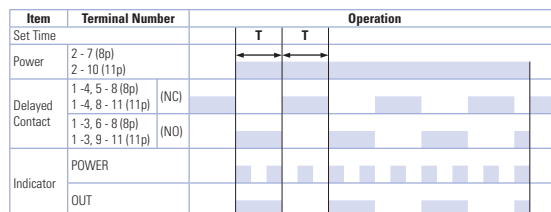

GT3A-4 Timing Diagrams  
Delayed DPDT

Operation  
Mode Selection

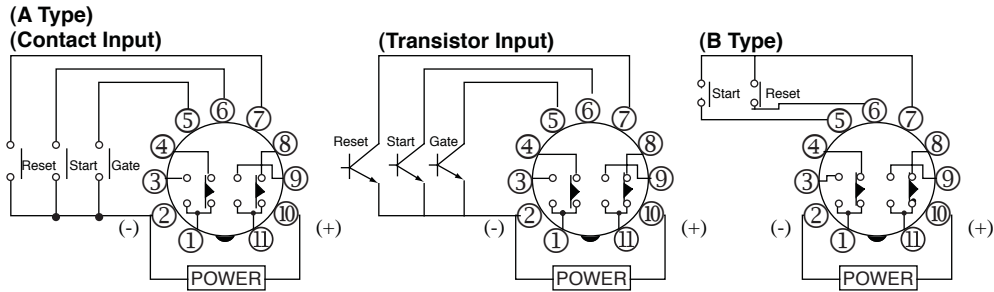

ON-Delay 2

MODE

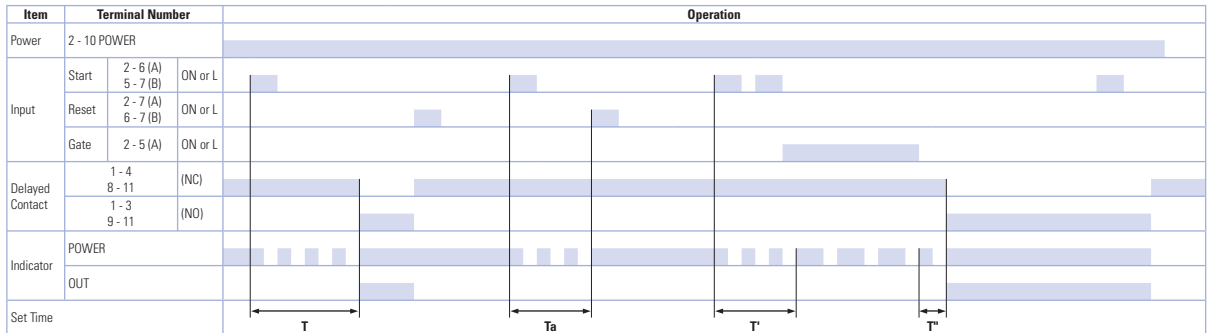

Cycle 2

MODE

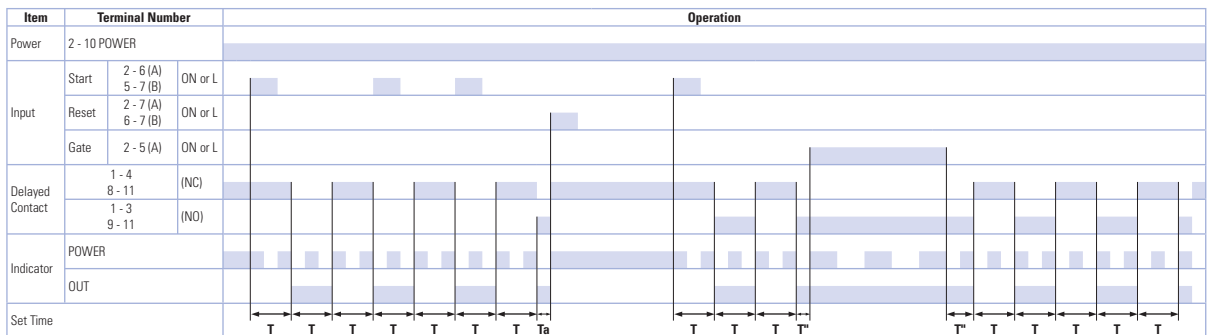

Signal ON/OFF-Delay 1

MODE

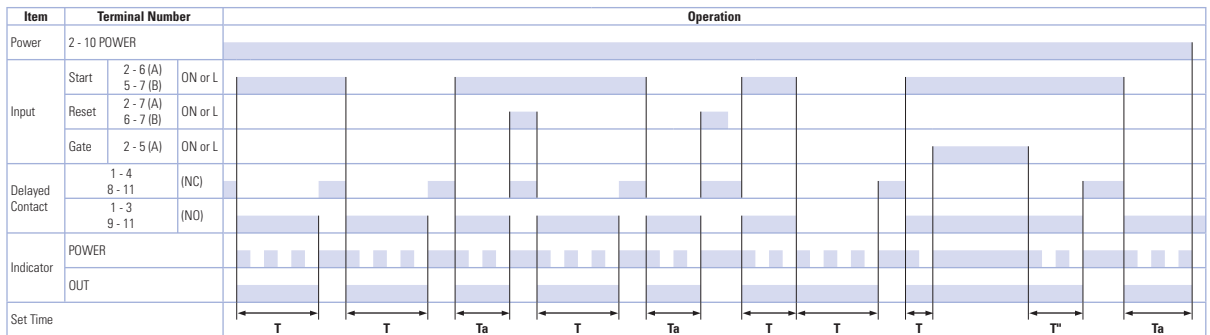

Signal OFF-Delay 1

MODE

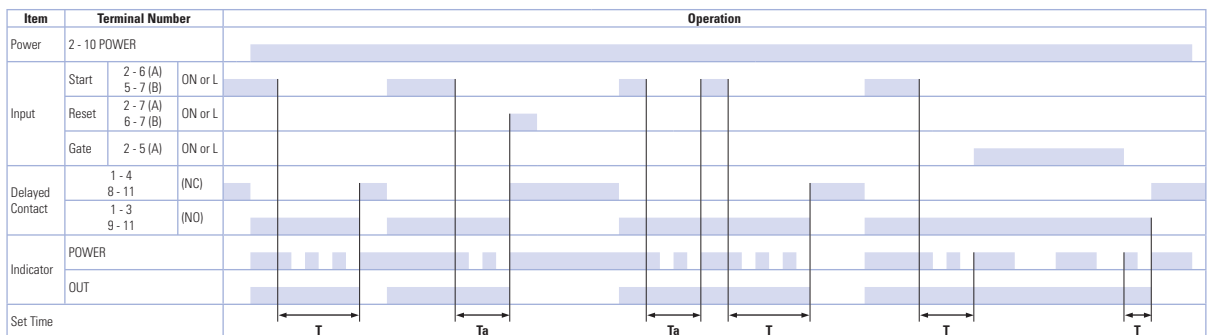

T = Set time Ta = Shorter than set time  
T = T' + T''

GT3A-5 Timing Diagrams  
Delayed DPDT

Operation  
Mode Selection

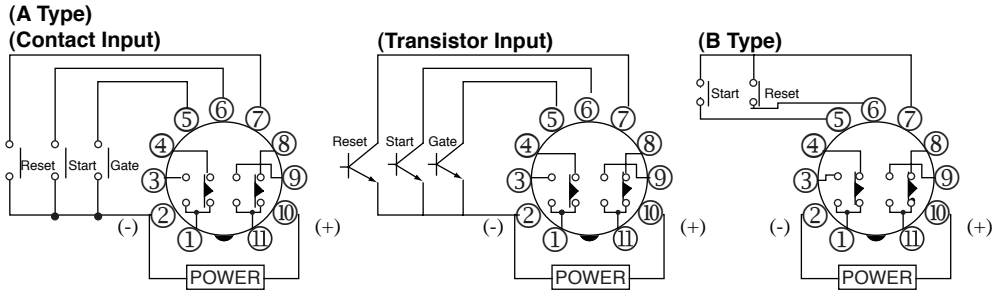

Interval 2

MODE

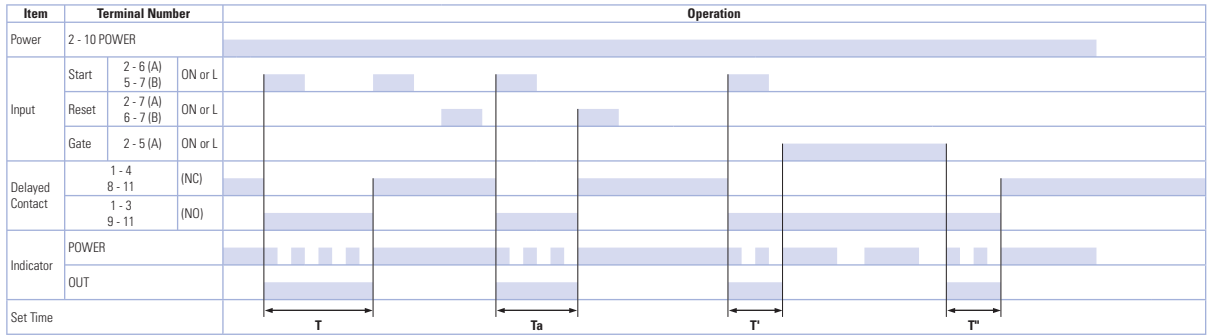

One-Shot Cycle

MODE

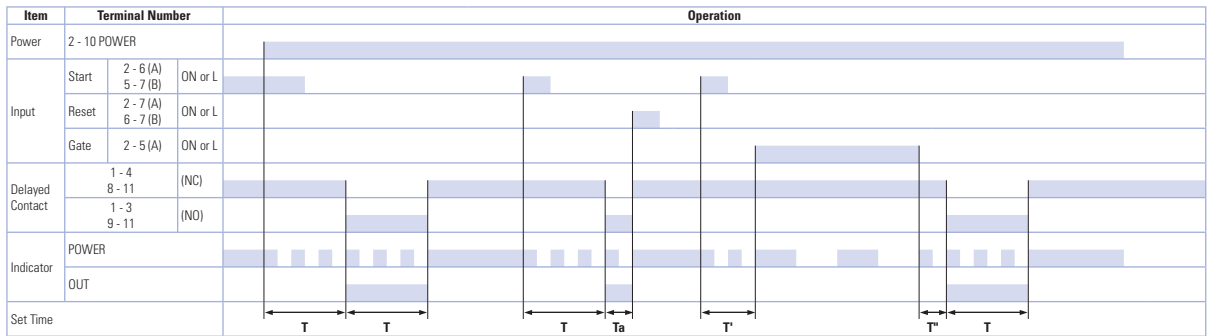

Signal ON/OFF-Delay 2

MODE

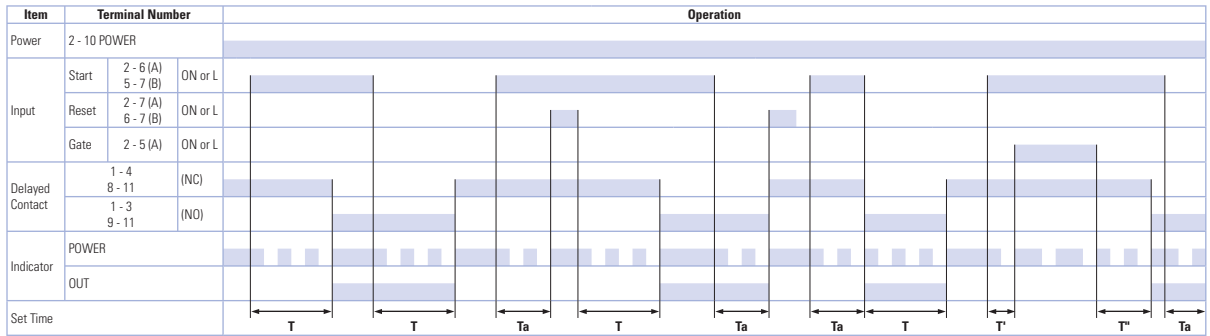

Signal OFF-Delay 2

MODE

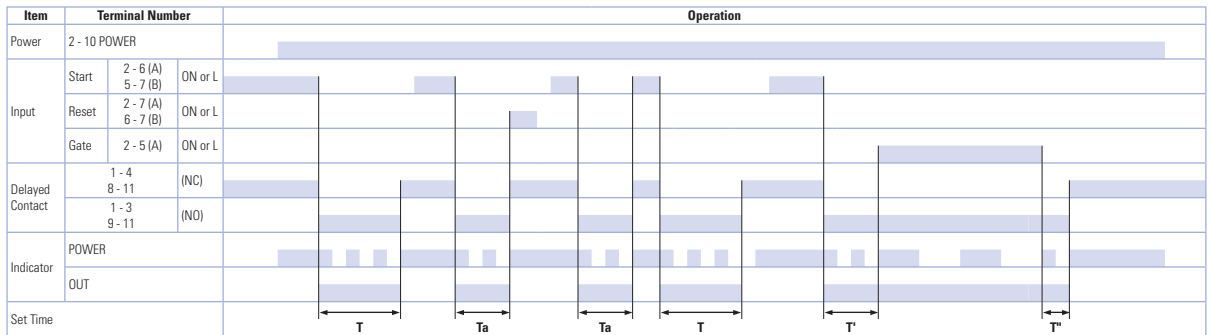

T = Set time Ta = Shorter than set time  
T = T' + T''

GT3A-6 Timing Diagrams  
Delayed DPDT

Operation  
Mode Selection

(A Type)  
(Contact Input)

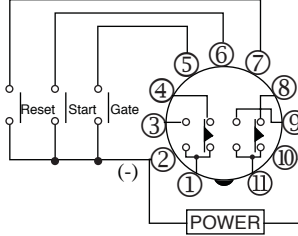

(Transistor Input)

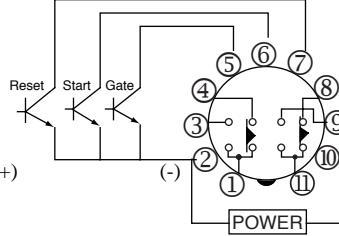

(B Type)

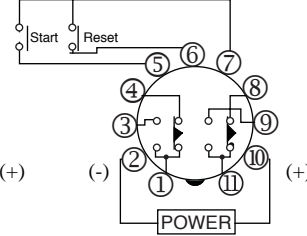

One-Shot 1

MODE

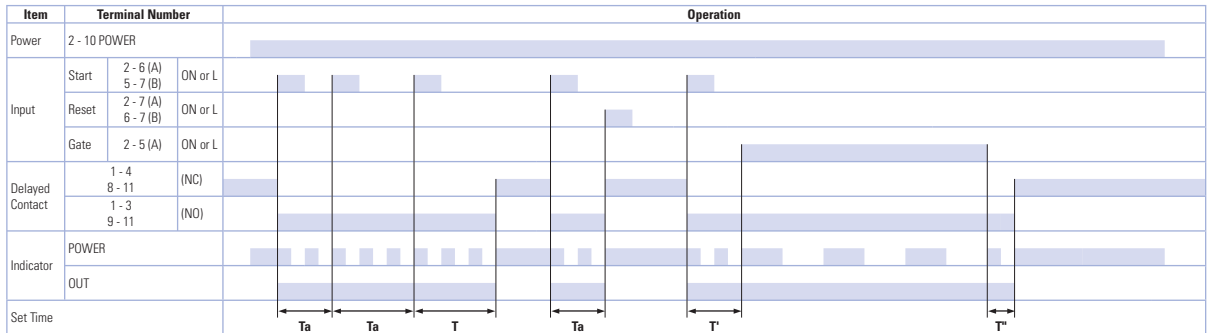

One-Shot ON-Delay

MODE

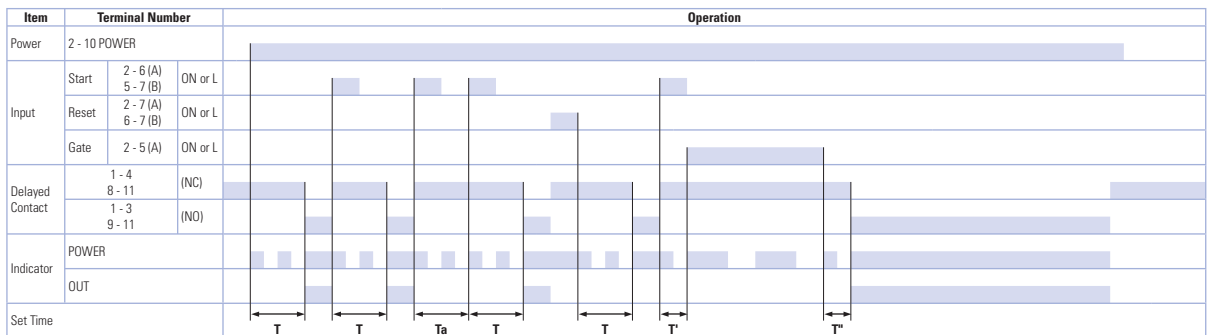

One-Shot 2

MODE

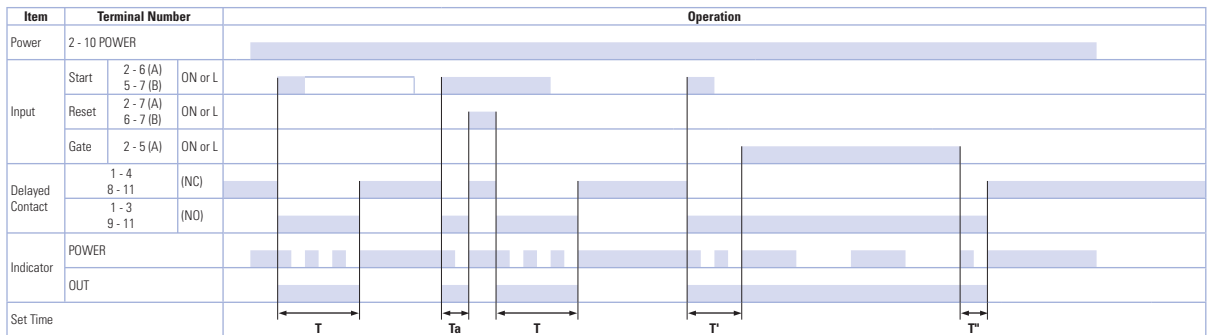

Signal ON/OFF-Delay 3

MODE

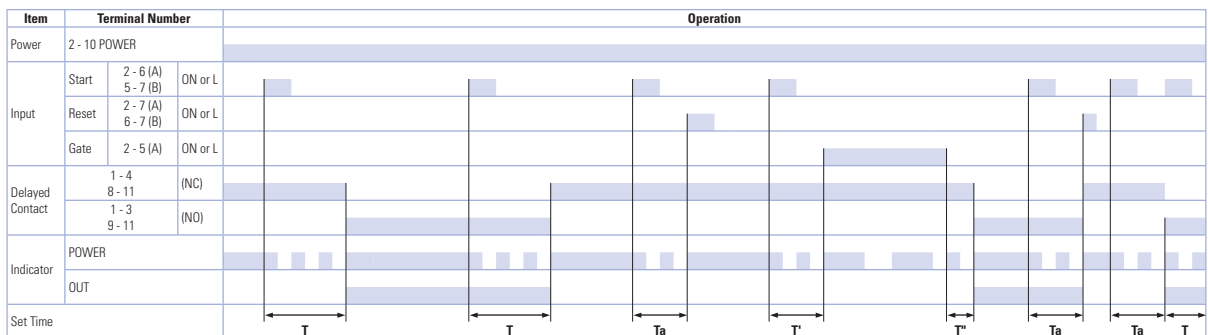

T = Set time  $T_a$  = Shorter than set time  
 $T = T' + T''$

Instructions: Setting GT3A Series Timers



Step 1.	Desired Mode of Operation		Selection		Remarks		
	For Timers	Mode of Operation	① Operation Mode Selector				
Select the desired mode of operation.	GT3A-1 GT3A-2 GT3A-3	ON-delay 1	A		The desired operation mode can be selected from the A, B, C, and D modes using the Operation Mode Selector. Change the operation mode from A to B, C, and D in turn by turning the operation mode selector clockwise using a flat screwdriver which is a maximum of 0.156" (4mm) wide. The selected mode is displayed in the window.		
		Interval 1	B				
		Cycle 1	C				
		Cycle 3	D				
	GT3A-4	ON-delay 2	A				
		Cycle 2	B				
		Signal ON/OFF-delay 1	C				
		Signal OFF-delay 1	D				
	GT3A-5	Interval 2	A				
		One-shot cycle	B				
		Signal ON/OFF-delay 2	C				
		Signal OFF-delay 2	D				
	GT3A-6	One-shot 1	A				
		One-shot ON-delay	B				
		One-shot 2	C				
		Signal ON/OFF-delay 3	D				
	Step 2.	Desired Time Range		Selection		Remarks	
		Time Ranges		② Dial Selector		③ Time Range Selector	
Select the time range that contains the desired time period.	0.05 seconds to 1 second		0-1	1S	The desired time range is selected by setting both ② Dial Selector and ③ Time Range Selector.		
	0.1 seconds to 3 seconds		0-3				
	0.1 seconds to 6 seconds		0-6				
	0.15 seconds to 18 seconds		0-18				
	0.1 seconds to 10 seconds		0-1	10S			
	0.3 seconds to 30 seconds		0-3				
	0.6 seconds to 60 seconds		0-6				
	1.8 seconds to 180 seconds		0-18				
	6 seconds to 10 minutes		0-1	10M			
	18 seconds to 30 minutes		0-3				
	36 seconds to 60 minutes		0-6				
	108 seconds to 180 minutes		0-18				
	6 minutes to 10 hours		0-1	10H			
	18 minutes to 30 hours		0-3				
	36 minutes to 60 hours		0-6				
	108 minutes to 180 hours		0-18				
Step 3.	Selection						
Set the precise period of time desired by using the ④ Setting Knob.							

Switches & Pilot Lights

Display Lights

Relays & Sockets

Timers

Terminal Blocks

Circuit Breakers



## GT3D – Digital Timers

### Key features of the GT3D series include:

- Precise time setting using digital thumbwheel switches
- Elapsed or time remaining LCD display
- 6 time ranges, 16 timing functions
- Time delays up to 99.9 hours



UL Recognized  
File No. E55996

Cert. No. BL9801133323911 (LVD)  
Cert. No. E9971113332388 (EMC)



CSA Certified  
File No. LR58183  
File No. LR96764  
File No. LR83814



### Specifications

		GT3D-2	GT3D-3	GT3D-4	GT3D-8
<b>Operation System</b>		Solid state CMOS circuitry			
<b>Operation</b>		Multi-mode			Multi-mode one-shot output
<b>Time Range</b>		0.01s to 99.9 hours			
<b>Rated Voltage</b>		100 to 240V AC (50/60Hz), 24V AC (50/60Hz)/24V DC			
<b>Contact Ratings</b>		125V AC/250V AC, 3A; 30V DC/1A (resistive load)	125V AC/250V AC, 5A; 30V DC/5A (resistive load)		
<b>Contact Form</b>		Delayed SPDT + instantaneous SPDT	Delayed DPDT	Delayed DPDT	Delayed DPDT
<b>Minimum Applicable Load</b>		5V, 10mA (reference value)			
<b>Voltage Tolerance</b>		AF20 (100–240V AC): 85 to 264V AC AD24 (AC): 20.4 to 26.4V AC AD24 (DC): 21.6 to 26.4V DC			
<b>Error</b>		±0.3% ±50ms (voltage, repeat, and temperature)			
<b>Setting Error</b>		±0.5% ±50ms			
<b>Reset Time</b>		60ms maximum			
<b>Insulation Resistance</b>		100MΩ minimum			
<b>Dielectric Strength</b>		Between power and output terminals: 2,000V AC, 1 minute Between contacts of different poles: 2,000V AC, 1 minute Between contacts of the same pole: 750V AC, 1 minute			
<b>Power Consumption</b> (approximate)	<b>AF20</b>	11.8VA	11.6VA	3.7VA (100V AC, 60Hz) 11.6VA (200V AC, 60Hz)	
	<b>AD24 AC/DC</b>	1VA/0.8W	2.1VA/0.9W	2.1VA /0.9W	
<b>Mechanical Life</b>		10,000,000 operations minimum	5,000,000 operations minimum		
<b>Electrical Life (at rated load)</b>		50,000 operations minimum	100,000 operations minimum		
<b>Outputs</b>	<b>Relay</b>	250V AC, 3A, 30V DC, 1A (resistive load)	240V AC/, 24V DC, 5A (resistive load)		
<b>Vibration Resistance</b>		100N (approximate 10G)			
<b>Shock Resistance</b>		Operating extremes: 100N (approximate 10G) Damage limits: 500N (approximate 50G)			
<b>Operating Temperature</b>		–10 to +50°C			
<b>Storage Temperature</b>		–30 to +80°C			
<b>Operating Humidity</b>		45 to 85% RH			
<b>Weight (approximate)</b>		70g	75g	76g	
<b>Housing Color</b>		Gray			

**Part Number List**
**Part Numbers: GT3D-1/GT3D-2/GT3D-3**

Mode of Operation	Time Range	Output	Contact	Rated Voltage Code	Complete Part No.	
					8-Pin	11-Pin
1-A: ON-delay 1 1-B: Interval 1 first 1-C: Cycle 1 (OFF first) 1-D: Cycle 3 (ON first)	0.01s to 99.9 hours	250V AC, 3A, 30V DC, 1A (resistive load)	Delayed SPDT + instantaneous SPDT	100 to 240V AC (50/60Hz)	GT3D-2AF20	GT3D-2EAF20
				24V AC/DC	GT3D-2AD24	—
		240V AC, 24V DC, 5A (resistive load)		100 to 240V AC (50/60Hz)	GT3D-3AF20	GT3D-3EAF20
				24V AC/DC	GT3D-3AD24	—

**Part Numbers: GT3D-4**

Mode of Operation	Time Range	Output	Contact	Rated Voltage Code	Complete Part No.	
					A (11-Pin)	B (11-Pin)
1-A: ON-delay 1 1-B: Interval 1 first 1-C: Cycle 1 (OFF first) 1-D: Cycle 3 (ON first) 2-A: ON-delay 2 2-B: Cycle 2 2-C: Signal ON/OFF-delay 1 2-D: Signal OFF-delay 1 2-E: Interval 2 2-F: One-shot cycle 3-A: Signal ON/OFF-delay 2 3-B: Signal OFF-delay 2 3-C: One-shot 1 3-D: One-shot ON-delay 3-E: One-shot 2 3-F: Signal ON/OFF-delay 3	0.01s to 99.9 hours	240V AC/24V DC, 5A (resistive load)	Delayed DPDT	100 to 240V AC (50/60Hz)	GT3D-4AF20	GT3D-4EAF20
				24V AC/DC	GT3D-4AD24	—

**Part Numbers: GT3D-8**

Mode of Operation	Time Range	Output	Contact	Rated Voltage Code	Complete Part No. (11-Pin)
1: ON-delay one-shot 1 2: Cycle one-shot 3: ON-delay one-shot 2	0.01s to 99.9 hours	240V AC/24V DC, 5A (resistive load)	Delayed DPDT	100 to 240V AC (50/60Hz)	GT3D-8AF20
				24V AC/DC	GT3D-8AD24

- 
1. For wiring schematics and timing diagrams GT3D, see pages 815 to 822.
  2. For more details about time ranges, see instructions on page 823.
  3. A (11-pin) and B (11-pin) differ in the way inputs are wired.
  4. For socket and accessory part numbers, see page 838.
  5. For timing diagrams overview, see page 794.

Timing Diagrams/Schematics

GT3D-2 Timing Diagrams  
Delayed SPDT + Instantaneous SPDT

Operation  
Mode Selection

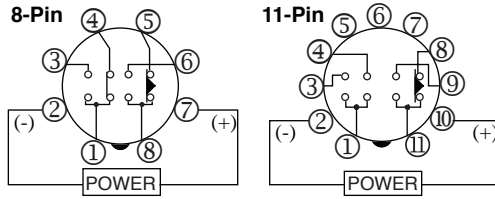

ON-Delay 1

Time Remaining

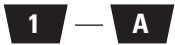

Time Elapsed

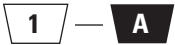

Item	Terminal Number	Operation
Set Time		Set Time
Power	2 - 7 (8p) 2 - 10 (11p)	
Delayed Contact	1 - 4, 5 - 8 (8p) (NC)	
	1 - 4, 8 - 11 (11p) (NO)	
	1 - 3, 6 - 8 (8p) (NO) 1 - 3, 9 - 11 (11p) (NO)	
Instantaneous Contact	1 - 4 (NC)	
	1 - 3 (NO)	
Indicator	OUT	
Digital Time Display	DOWN	
	UP	

Interval 1

Time Remaining

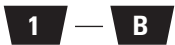

Time Elapsed

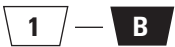

Item	Terminal Number	Operation
Set Time		Set Time
Power	2 - 7 (8p) 2 - 10 (11p)	
Delayed Contact	1 - 4, 5 - 8 (8p) (NC)	
	1 - 4, 8 - 11 (11p) (NO)	
	1 - 3, 6 - 8 (8p) (NO) 1 - 3, 9 - 11 (11p) (NO)	
Instantaneous Contact	1 - 4 (NC)	
	1 - 3 (NO)	
Indicator	OUT	
Digital Time Display	DOWN	
	UP	

Cycle 1

(OFF first)

Time Remaining

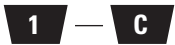

Time Elapsed

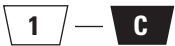

Item	Terminal Number	Operation
Set Time		Set Time
Power	2 - 7 (8p) 2 - 10 (11p)	
Delayed Contact	1 - 4, 5 - 8 (8p) (NC)	
	1 - 4, 8 - 11 (11p) (NO)	
	1 - 3, 6 - 8 (8p) (NO) 1 - 3, 9 - 11 (11p) (NO)	
Instantaneous Contact	1 - 4 (NC)	
	1 - 3 (NO)	
Indicator	OUT	
Digital Time Display	DOWN	
	UP	

Cycle 3

(ON first)

Time Remaining



Time Elapsed

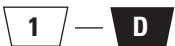

Item	Terminal Number	Operation
Set Time		Set Time
Power	2 - 7 (8p) 2 - 10 (11p)	
Delayed Contact	1 - 4, 5 - 8 (8p) (NC)	
	1 - 4, 8 - 11 (11p) (NO)	
	1 - 3, 6 - 8 (8p) (NO) 1 - 3, 9 - 11 (11p) (NO)	
Instantaneous Contact	1 - 4 (NC)	
	1 - 3 (NO)	
Indicator	OUT	
Digital Time Display	DOWN	
	UP	

GT3D-3 Timing Diagrams  
Delayed DPDT

Operation  
Mode Selection

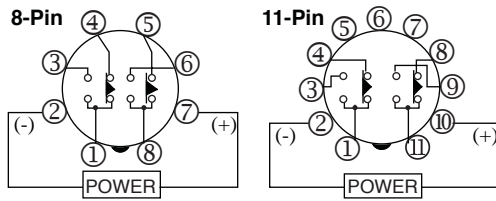

ON-Delay 1

Time Remaining

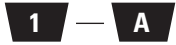

Time Elapsed

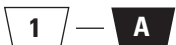

Item	Terminal Number	Operation
Set Time		Set Time
Power	2 - 7 (8p) 2 - 10 (11p)	
Delayed Contact	1 - 4, 5 - 8 (8p) 1 - 4, 8 - 11 (11p)	(NC)
Indicator	OUT	
Digital Time Display	DOWN UP	

Interval 1

Time Remaining



Time Elapsed

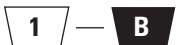

Item	Terminal Number	Operation
Set Time		Set Time
Power	2 - 7 (8p) 2 - 10 (11p)	
Delayed Contact	1 - 4, 5 - 8 (8p) 1 - 4, 8 - 11 (11p)	(NC)
Indicator	OUT	
Digital Time Display	DOWN UP	

Cycle 1

(OFF first)

Time Remaining



Time Elapsed

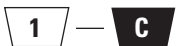

Item	Terminal Number	Operation
Set Time		Set Time
Power	2 - 7 (8p) 2 - 10 (11p)	
Delayed Contact	1 - 4, 5 - 8 (8p) 1 - 4, 8 - 11 (11p)	(NC)
Indicator	OUT	
Digital Time Display	DOWN UP	

Cycle 3

(ON first)

Time Remaining



Time Elapsed

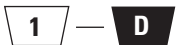

Item	Terminal Number	Operation
Set Time		Set Time
Power	2 - 7 (8p) 2 - 10 (11p)	
Delayed Contact	1 - 4, 5 - 8 (8p) 1 - 4, 8 - 11 (11p)	(NC)
Indicator	OUT	
Digital Time Display	DOWN UP	

### GT3D-4 Timing Diagrams

These timers require a start input. A gate and reset input are optional. Inputs are controlled by external pushbuttons. Reset occurs when the power is removed or when the reset input is supplied. The gate signal can be used to interrupt (freeze) timer functions. Timer functions resume when the gate input is removed. B style timers are not equipped for gate input.

#### Delayed DPDT

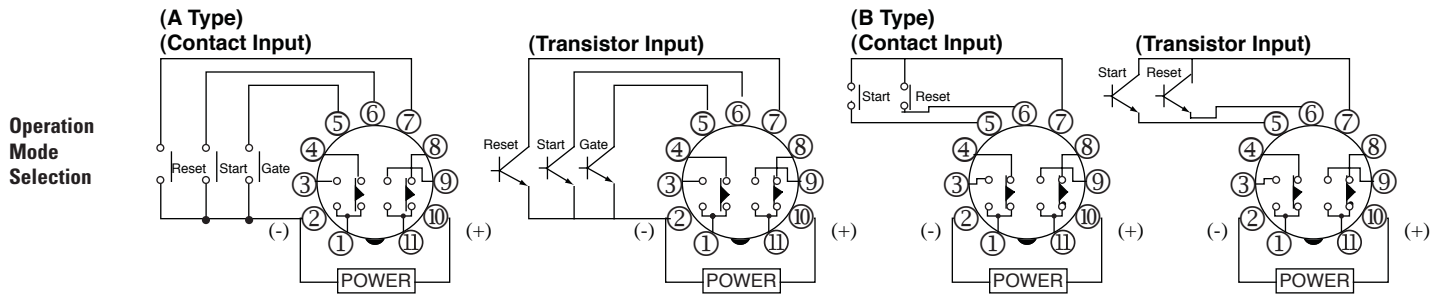

#### ON-Delay 1

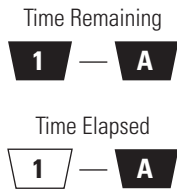

Item	Terminal Number	Operation
Power	2 - 10	[Timing diagram showing power pulse]
Delayed Contact	(NC) 1 - 4 8 - 11	[Timing diagram showing normally closed contact]
	(NO) 1 - 3 9 - 11	[Timing diagram showing normally open contact]
Indicator	OUT	[Timing diagram showing indicator output]
Digital Time Display	DOWN	[Timing diagram showing digital display down]
	UP	[Timing diagram showing digital display up]
Set Time		[Timing diagram showing set time interval]

#### Interval 1

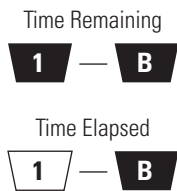

Item	Terminal Number	Operation
Power	2 - 10	[Timing diagram showing power pulse]
Delayed Contact	(NC) 1 - 4 8 - 11	[Timing diagram showing normally closed contact]
	(NO) 1 - 3 9 - 11	[Timing diagram showing normally open contact]
Indicator	OUT	[Timing diagram showing indicator output]
Digital Time Display	DOWN	[Timing diagram showing digital display down]
	UP	[Timing diagram showing digital display up]
Set Time		[Timing diagram showing set time interval]

**GT3D-4 Timing Diagrams**

**Cycle 1**  
(OFF first)

Time Remaining



Time Elapsed

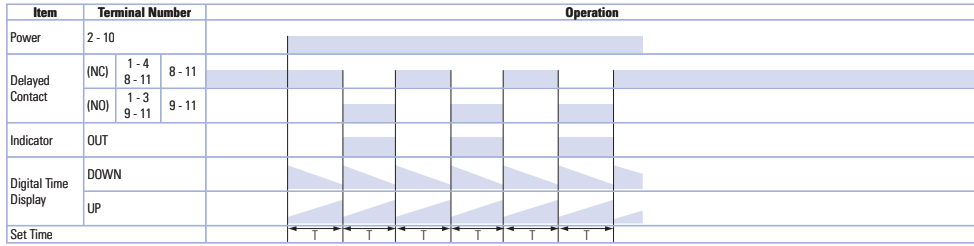
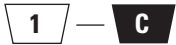

**Cycle 3**  
(ON first)

Time Remaining



Time Elapsed

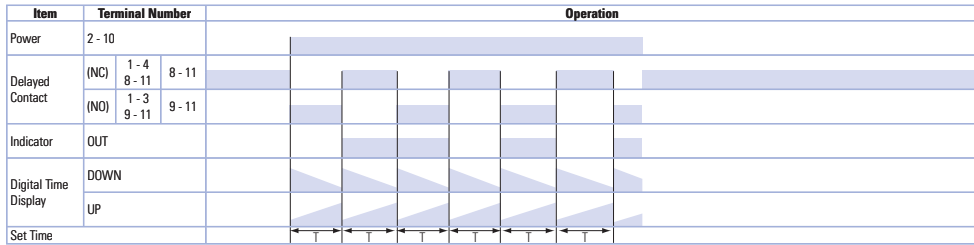
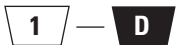

**ON-Delay 2**

Time Remaining



Time Elapsed

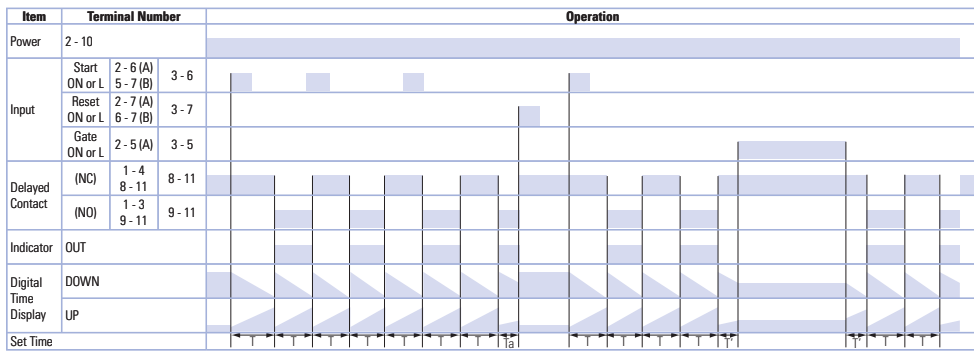
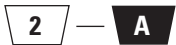

Switches & Pilot Lights

Display Lights

Relays & Sockets

Timers

Terminal Blocks

Circuit Breakers

GT3D-4 Timing Diagrams

Cycle 2

Time Remaining



Time Elapsed

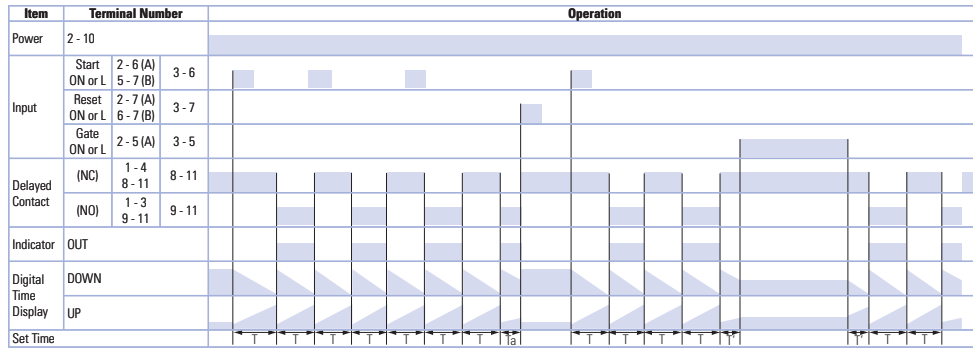
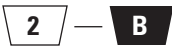

Signal ON/OFF-Delay 1

Time Remaining



Time Elapsed

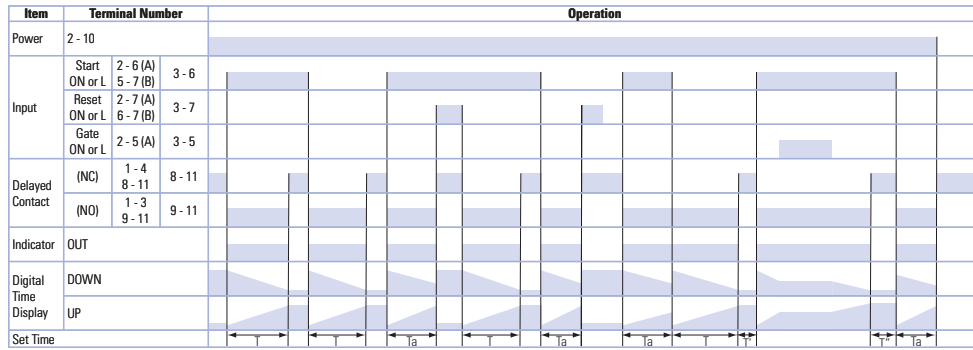
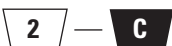

Singal OFF-Delay 1

Time Remaining



Time Elapsed

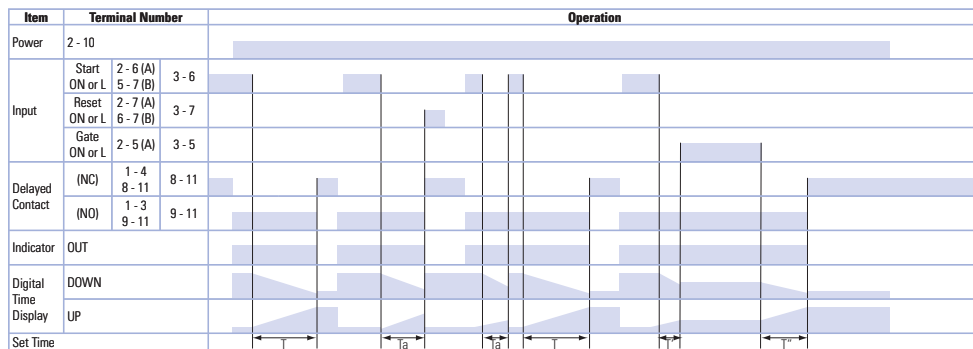
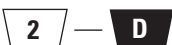

Interval 2

Time Remaining



Time Elapsed

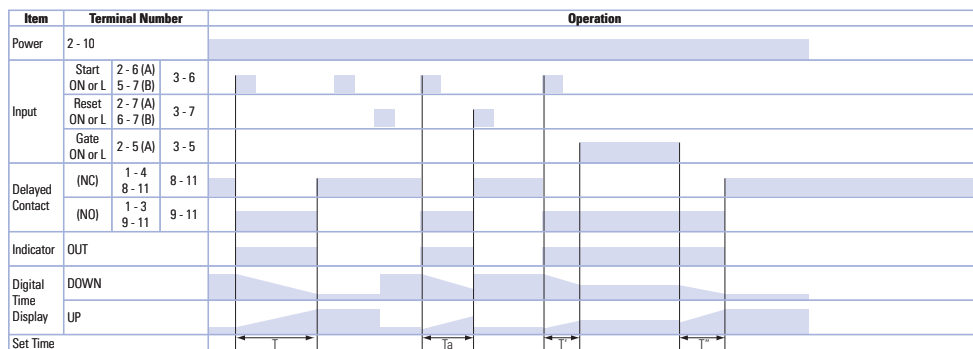
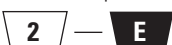



**GT3D-4 Timing Diagrams**

Switches & Pilot Lights

**One-Shot Cycle**

Time Remaining



Time Elapsed

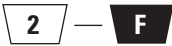

Display Lights

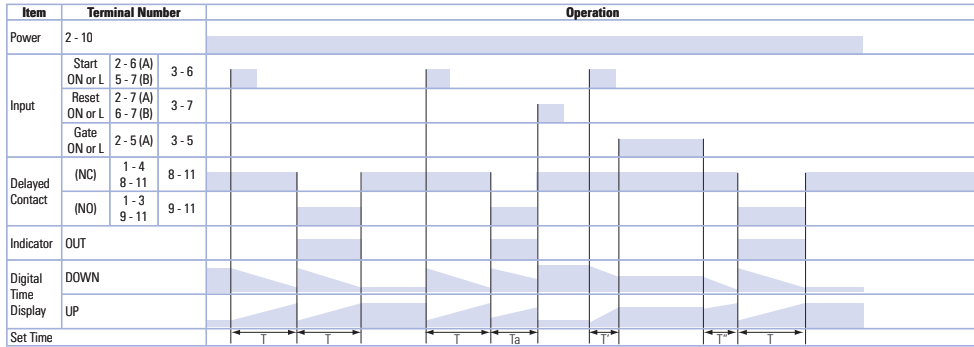

Relays & Sockets

**Signal ON/OFF-Delay 2**

Time Remaining



Time Elapsed

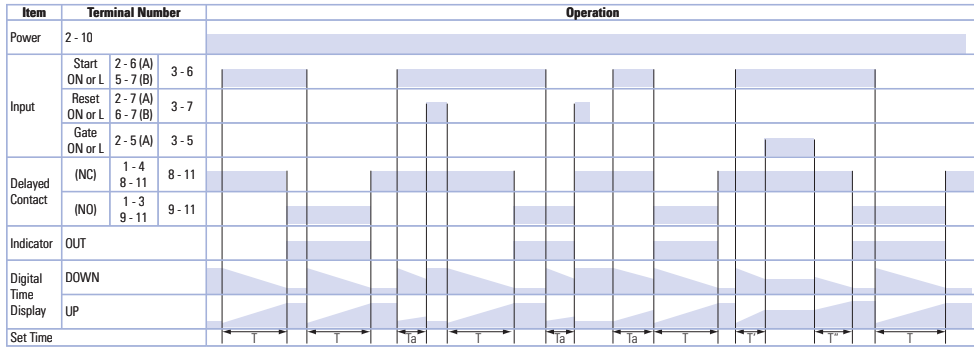
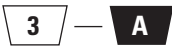

Timers

**Singal OFF-Delay 2**

Time Remaining



Time Elapsed

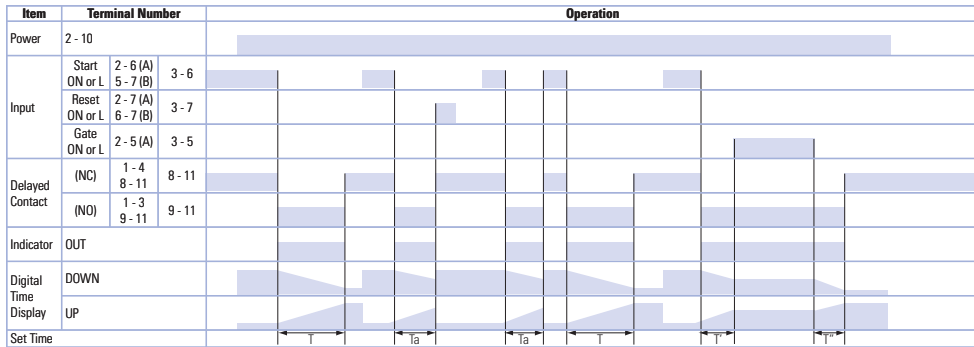
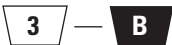

Terminal Blocks

**One-Shot 1**

Time Remaining



Time Elapsed

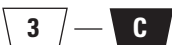

Circuit Breakers

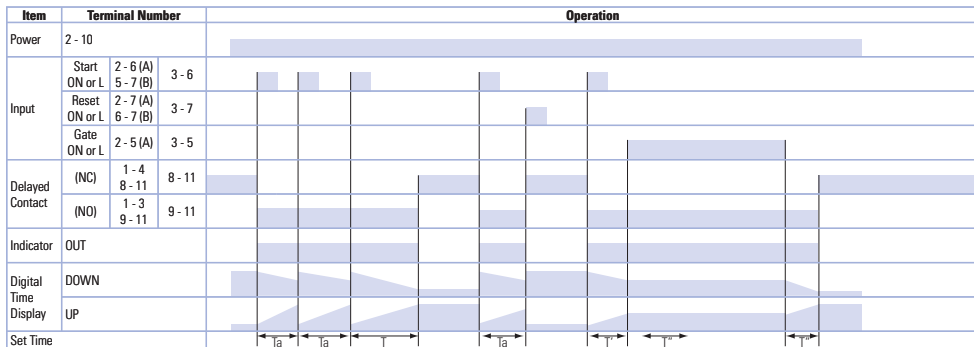

GT3D-4 Timing Diagrams

One-Shot ON-Delay

Time Remaining



Time Elapsed

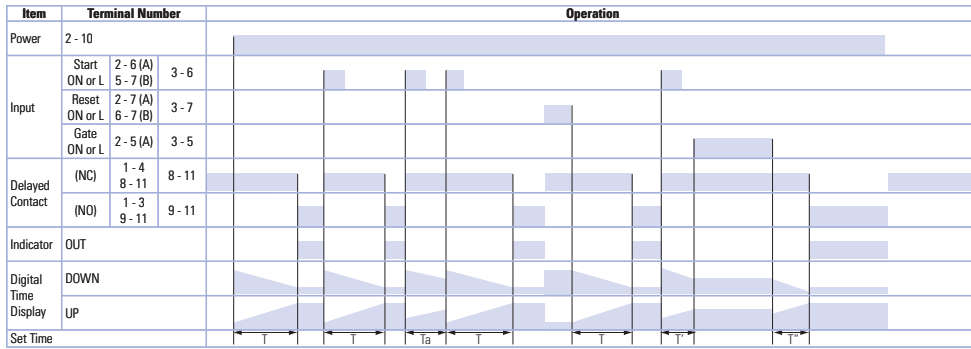
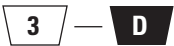

One-Shot 2

Time Remaining

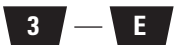

Time Elapsed

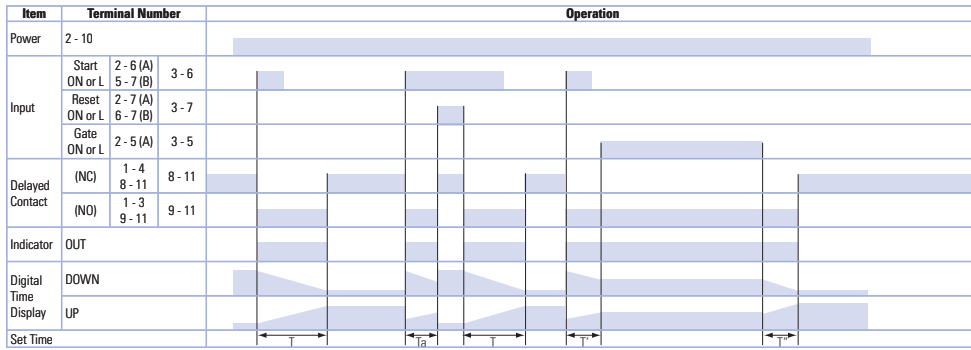
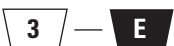

Signal ON/OFF-Delay 3

Time Remaining

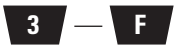

Time Elapsed

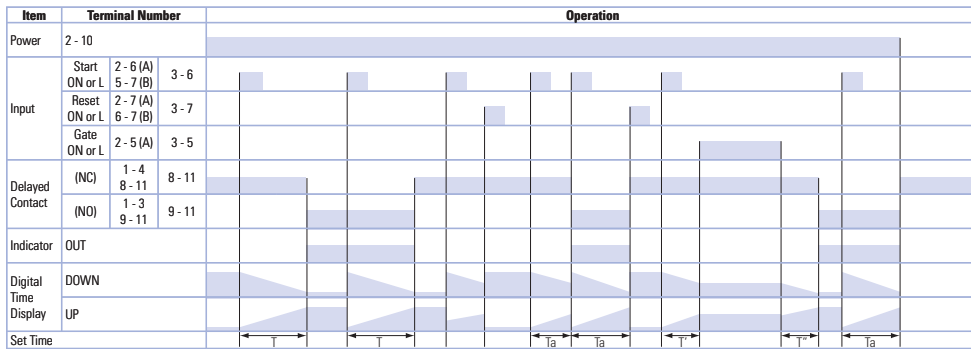
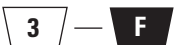

Switches & Prior Lights

Display Lights

Relays & Sockets

Timers

Terminal Blocks

Circuit Breakers

GT3D-8 Timing Diagrams  
Delayed DPDT

Operation  
Mode Selection

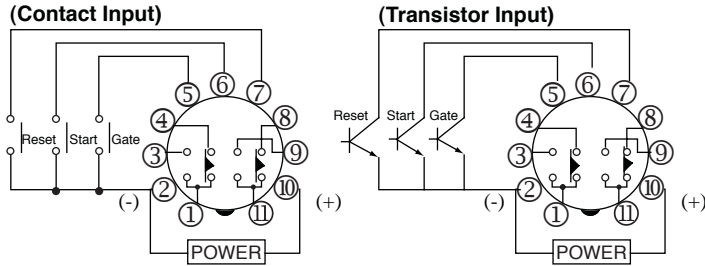

ON-Delay One-Shot 1

Time Remaining **1**  
Time Elapsed **1**

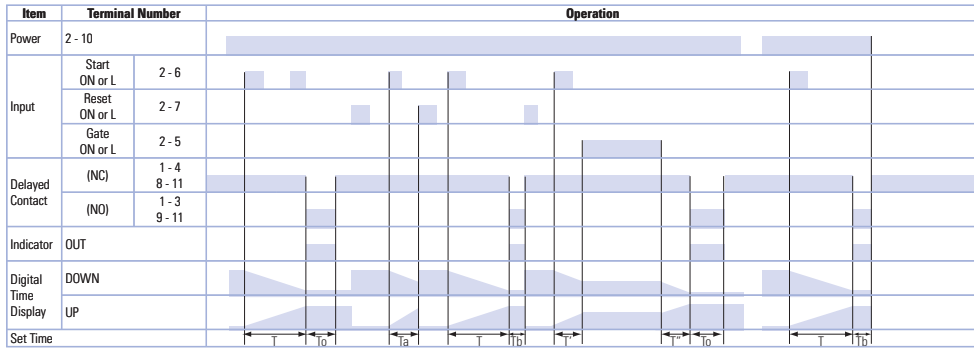

Cycle One-Shot

Time Remaining **2**  
Time Elapsed **2**

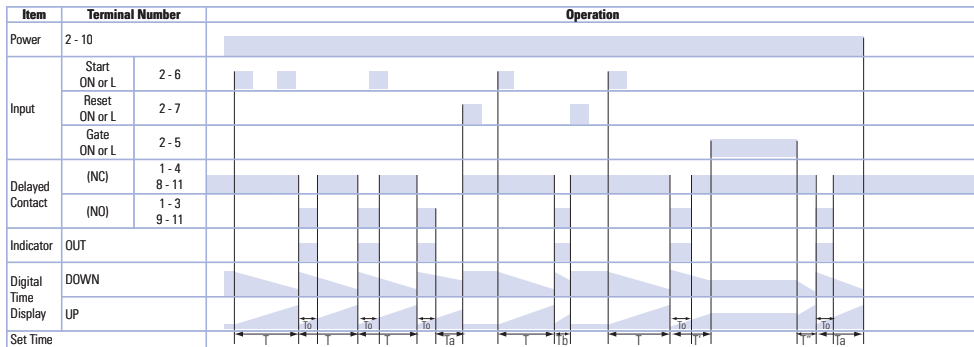

ON-Delay One-Shot 2

Time Remaining **3**  
Time Elapsed **3**

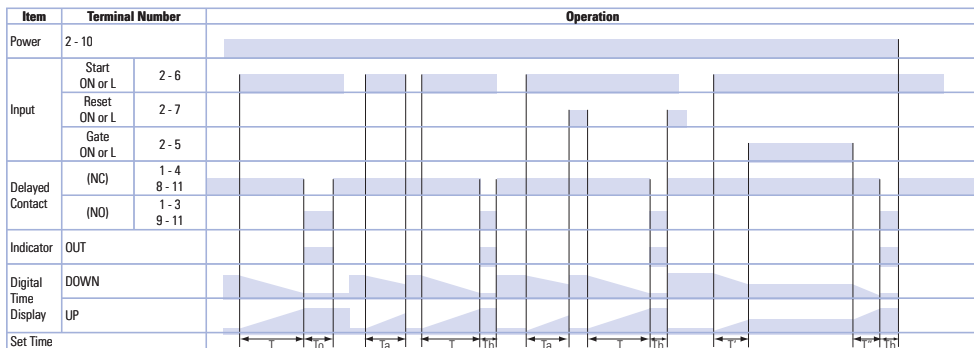

T = Set time  
 T<sub>a</sub> = Shorter than set time  
 T<sub>b</sub> = Shorter than single-shot output time  
 T = T' + T"  
 T<sub>0</sub> = Single-shot output time (selected from A, B, C, D, E or F)

Instructions: Setting GT3D-2, GT3D-3 Timers

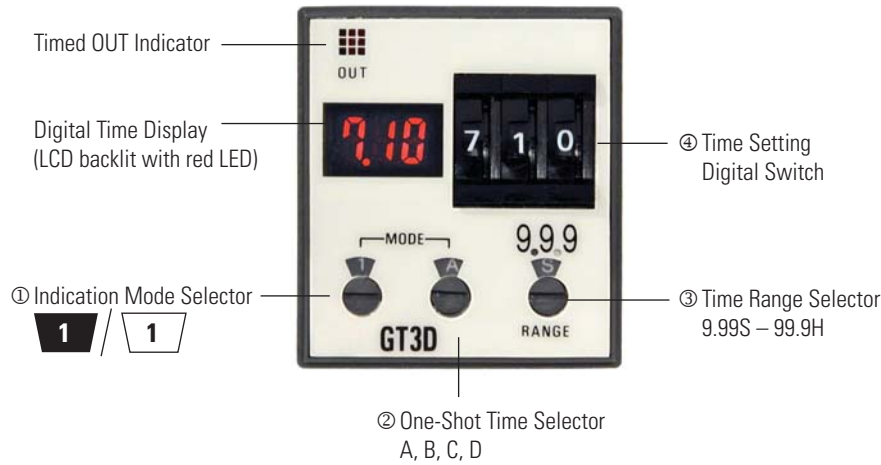

Step 1	Desired Mode/Selection				Remarks
Select the desired time display and operation modes.	Time Display Mode	① Indicator Mode Selector	Operation Mode	② Operation Mode Selector	1. Use the flat screwdriver to set the selectors. Since selectors do not turn all the way around, both clockwise and counterclockwise rotation may be necessary. 2. The ① Indicator Mode Selector determines whether the Digital Time Display shows the time elapsed or time remaining. The ② Operation Mode Selector determines the desired operation mode. Decide which display and mode is desired, then use these two selectors ①② to set the operation mode. 3. The ① Operation Mode Selector has two blank modes which are not intended for use. Always have this selector set to A, B, C, or D.
	Time elapsed		ON-delay 1	A	
	Time remaining				
	Time elapsed		Interval	B	
	Time remaining				
	Time elapsed		Cycle 1	C	
	Time remaining				
	Time elapsed		Cycle 3	D	
	Time remaining				
Step 2	Desired Operation	Selection		Remarks	
Select a time range that contains the desired period of time.	Base Time Ranges	③ Time Range Selector		1. The ③ Time Range Selector controls both the decimal point indicator (9.99, 99.9, 999) and the time increment indicators S (seconds), M (minutes), and H (hours). 2. Chose which base time range contains the targeted timer setting. Then use the ③ Time Range Selector to set the decimal point indicator and time increment indicator to its corresponding pair of settings. 3. Since these configurations offer a complete range of settings from 0.01 seconds to 99.9 hours, the setting of 9.99 for minutes and the 9.99 and 999 settings for hours are not listed and should not be used.	
		Decimal Point Indicator	Time Increment Indicator		
	0.01 seconds to 9.99 seconds	9.99			
	0.1 seconds to 99.9 seconds	99.9			
	1 second to 999 seconds	999			
	0.1 minutes to 99.9 minutes	99.9			
1 minute to 999 minutes	999				
0.1 hours to 99.9 hours	99.9				
Step 3	Desired Operation	Selection		Remarks	
Set the precise period of time desired by using the ④ Time Setting Digital Switch.				Use the ④ Time Setting Digital Switch to set the desired period of time. It is important to remember that the setting of the ③ Time Range Selector determines the units of time measurement as well as the implied decimal point location.	

It is important to remember that the ③ Time Range Selector not only selects the time range but also influences the interpretation of the Digital Time Display. Changing the ③ Time Range Selector setting changes the units of time measurement (seconds, minutes, hours) as well as the decimal point location.

Switches & Pilot Lights

Display Lights

Relays & Sockets

Timers

Terminal Blocks

Circuit Breakers

Instructions: Setting GT3D-4 Timers

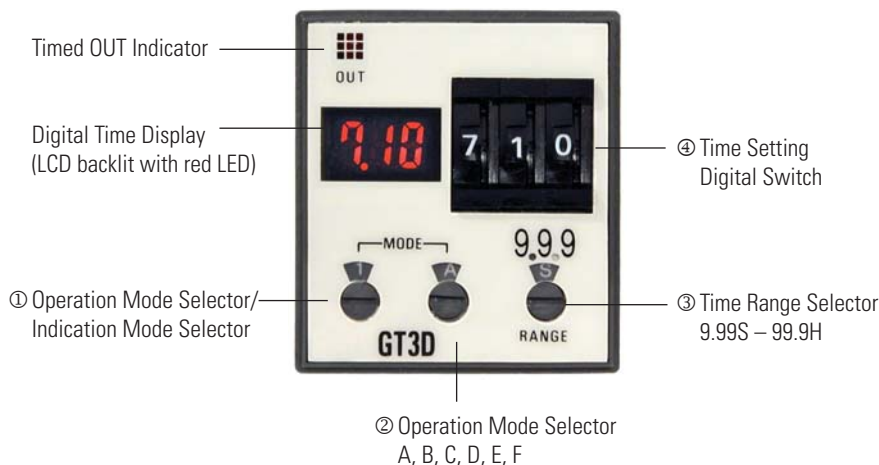

Step 1	Desired Mode/Selection				Remarks
	Time Display Mode	① Indicator Mode Selector	Operation Mode	② Operation Mode Selector	
Select the desired time display and operation modes.	Time elapsed		ON-delay 1 Interval 1 Cycle 1 D: Cycle 3	A B C D	1. Use a flat screwdriver to set the selectors. Since selectors do not turn all the way around, both clockwise and counterclockwise rotation is necessary.  2. The ① Indicator Mode Selector determines whether the Digital Time Display shows the time elapsed or time remaining. The ② Operation Mode Selector determines the desired operation mode. Decide which display and mode is desired; then use these two selectors ① ② to set the operation mode.  3. When using the indicator mode setting "1," the ② Operation Mode Selector has two blank modes which are not intended for use. When using mode setting "1," always have the operation mode selector set to A, B, C, or D.
	Time remaining				
	Time elapsed		ON-delay 2 Cycle 2 Signal ON/OFF-delay 2 Signal OFF-delay 1 Interval 2 One-shot cycle	A B C D E F	
	Time remaining				
	Time elapsed		Signal ON/OFF-delay 2 Signal OFF-delay 2 One-shot 1 One-shot ON-delay One-shot 2 Signal ON/OFF-delay 3	A B C D E F	
	Time remaining				
Step 2	Desired Operation		Selection		Remarks
Select a time range that contains the desired period of time.	Base Time Ranges		③ Time Range Selector		1. The ③ Time Range Selector controls both the decimal point indicator (9.99, 99.9, 999) and the time increment indicators S (seconds), M (minutes), and H (hours).  2. Chose which base time range contains the targeted timer setting. Then use the ③ Time Range Selector to set the decimal point indicator and time increment indicator to its corresponding pair of settings.  3. Since these configurations offer a complete range of settings from 0.01 seconds to 99.9 hours, the setting of 9.99 for minutes and the 9.99 and 999 settings for hours are not listed and should not be used.
	0.01 seconds to 9.99 seconds	9.99			
	0.1 seconds to 99.9 seconds	99.9			
	1 second to 999 seconds	999			
	0.1 minutes to 99.9 minutes	99.9			
	1 minute to 999 minutes	999			
0.1 hours to 99.9 hours	99.9				
Step 3	Desired Operation		Selection		Remarks
Set the precise period of time desired by using the ④ Time Setting Digital Switch.					

It is important to remember that the ③ Time Range Selector not only selects the time range but also influences the interpretation of the Digital Time Display. Changing the ③ Time Range Selector setting changes the units of time measurement (seconds, minutes, hours) as well as the decimal point location.

Switches & Pilot Lights

Display Lights

Relays & Sockets

Timers

Terminal Blocks

Circuit Breakers

### Instructions: Setting GT3D-8 Timers

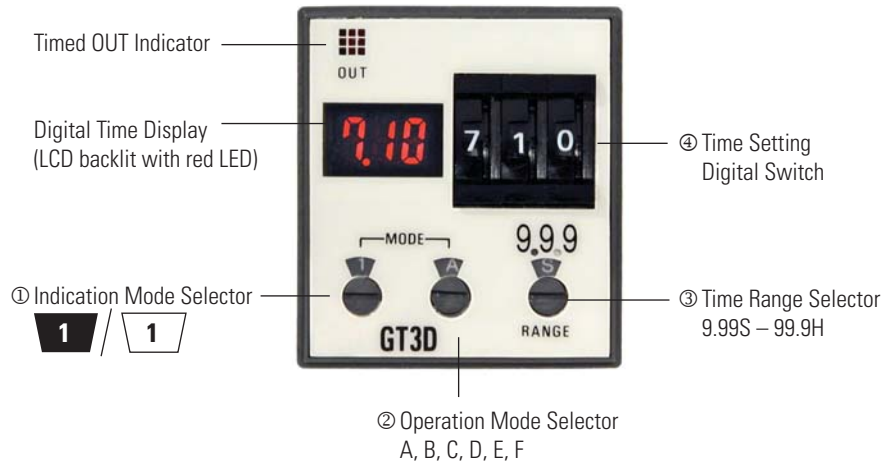

Step 1	Desired Mode of Operation		Selection		Remarks
Select the time display and operation modes.	Operation Mode	Time elapsed	① Indicator Mode Selector		1. Use a flat screwdriver to set the selectors. Since selectors do not turn all the way around, both clockwise and counterclockwise rotation is necessary. 2. The GT3D-8 ① Indicator Mode Selector selects both whether the Digital Time Display displays the time elapsed or time remaining and also the mode of operation. Decide which display and mode is desired. Then use this selector to set the operation mode.
		Time remaining	①		
	Cycle One-Shot	Time elapsed	②		
		Time remaining	②		
	ON-Delay One-Shot 2	Time elapsed	③		
		Time remaining	③		
Step 2	Desired Mode of Operation		Selection		Remarks
Select the single shot output time.	Desired Single-Shot Output Time		② Single-Shot Output Time Selector		On the GT3D-8 timers, the desired single-shot output time can be selected from the A, B, C, D, E, and F modes using the ② One-Shot Output Time Selector.
	0.1 seconds		A		
	0.5 seconds		B		
	1 second		C		
	5 seconds		D		
	10 seconds		E		
50 seconds		F			
Step 3	Desired Operation		Selection		Remarks
Select a time range that contains the desired period of time.	Base Time Ranges		③ Time Range Selector		1. The ③ Time Range Selector controls both the decimal point indicator (9.99, 99.9, 999) and the time increment indicators S (seconds), M (minutes), and H (hours). 2. Chose which base time range contains the targeted timer setting. Then use the ③ Time Range Selector to set the decimal point indicator and time increment indicator to its corresponding pair of settings. 3. Since these configurations offer a complete range of settings from 0.01 seconds to 99.9 hours, the setting of 9.99 for minutes and the 9.99 and 999 settings for hours are not listed and should not be used.
	0.01 seconds to 9.99 seconds		Decimal Point Indicator	Time Increment Indicator	
	0.1 seconds to 99.9 seconds		9.99	S	
	1 second to 999 seconds		99.9		
	0.1 minutes to 99.9 minutes		999	M	
	1 minute to 999 minutes		99.9		
	0.1 hours to 99.9 hours		999	H	
Step 4	Desired Operation		Selection		Remarks
Set the precise period of time desired by using the ④ Time Setting Digital Switch.					Use the ④ Time Setting Digital Switch to set the desired period of time. It is important to remember that the setting of the ③ Time Range Selector determines the units of time measurement as well as the implied decimal point location.



It is important to remember that the ③ Time Range Selector not only selects the time range but also influences the interpretation of the Digital Time Display. Changing the ③ Time Range Selector setting changes the units of time measurement (seconds, minutes, hours) as well as the decimal point location.

Switches & Pilot Lights

Display Lights

Relays & Sockets

Timers

Terminal Blocks

Circuit Breakers

GT3F Series – True OFF Delay Timers



Key features of the GT3F series include:

- “True” power OFF-delay up to 10 minutes
- No external control switch necessary
- Available with reset inputs
- Mountable in sockets or flush panel



Specifications

	GT3F-1	GT3F-2
<b>Operation</b>	True power OFF-delay	
<b>Time Range</b>	0.1 seconds to 600 seconds	
<b>Rated Voltage</b>	100 to 240V AC, 50/60Hz 24V AC/DC	
<b>Contact Rating</b>	250V AC/30V DC, 5A (resistive load)	250V AC/30V DC, 3A (resistive load)
<b>Contact Form</b>	SPDT	DPDT
<b>Minimum Power Application Time</b>	1 second	
<b>Voltage Tolerance</b>	AF20: 100 to 240V AC AD24: 21.6 to 26.4VDC, 20.4 to 26.4VAC	
<b>Repeat Error</b>	±0.2%, ±10 msec	
<b>Voltage Error</b>	±0.2%, ±10 msec	
<b>Temperature Error</b>	±0.2%, ±10 msec	
<b>Setting Error</b>	±10% maximum	
<b>Insulation Resistance</b>	100MW minimum	
<b>Dielectric Strength</b>	Between power and output terminals: 2,000V AC, 1 minute (SPDT) 1,500V AC, 1 minute (DPDT) Between contacts on different poles: 1,000V AC, 1 minute (DPDT) Between contacts of the same pole: 750V AC, 1 minute	
<b>Power Consumption</b>	AF20: 3.7VA (200V AC, 60Hz) AD24: 0.8W (DC), 1.2VA (AC)	
<b>Mechanical Life</b>	20,000,000 operations minimum	
<b>Electrical Life</b>	100,000 operations minimum	
<b>Vibration Resistance</b>	100m/sec <sup>2</sup> (approximate 10G)	
<b>Shock Resistance</b>	Operating extremes: 100 m/sec <sup>2</sup> (approximate 10G) Damage limits: 500 m/sec <sup>2</sup> (approximate 50G)	
<b>Operating Temperature</b>	-10 to +50°C	
<b>Storage Temperature</b>	-30 to +80°C	
<b>Operating Humidity</b>	45 to 85% RH	
<b>Weight (approximate)</b>	77g	79g

1. An inrush current flows during the minimum power application time. AF20: approximate 0.4A, AD24: approximate 1.2A
2. GT3F does not read the preset time range shown on the knob after power is turned off. Note that minimizing the preset time, by turning the knob to zero, does not shorten the delay time after power is removed.

Switches & Pilot Lights

Display Lights

Relays & Sockets

Timers

Terminal Blocks

Circuit Breakers



Part Numbering List

GT3F

Mode of Operation	Rated Voltage Code	Time Range	Output	Contact	Optional Input	Complete Part Number	
						8-Pin	11-Pin
Power OFF-delay	AF20: 100 to 240VAC (50/60Hz)	0.1 seconds to 600 seconds	250V AC, 5A,	Delayed SPDT	Reset	GT3F-1AF20	GT3F-1EAF20
			30V DC, 5A (resistive load)			GT3F-1AD24	GT3F-1EAD24
	AD24: 24V AC/DC		250V AC, 3A,	Delayed DPDT	None (8p) Reset (11p)	GT3F-2AF20	GT3F-2EAF20
			30V DC, 3A (resistive load)			GT3F-2AD24	GT3F-2EAD24



Optional reset input resets the contact to the OFF state before time out.

Timing Diagrams/Schematics

GT3F-1 Timing Diagrams

GT3F-1 (8-pin)	GT3F-1E (11-pin)
Delayed SPDT Output, with Reset Input	

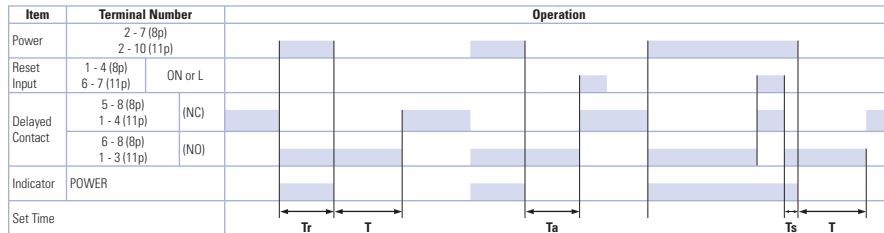
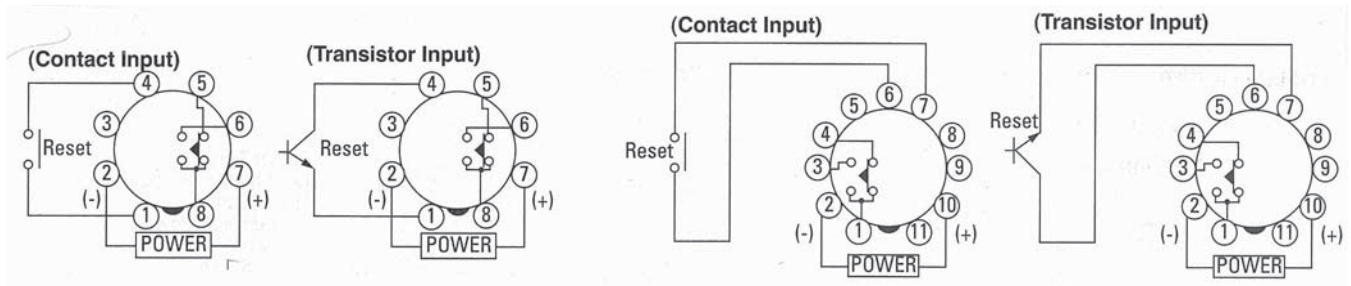

T = Set time  
 Ta = Shorter than set time  
 Ts = 1 Second  
 Tr = Minimum Power Application Time  
 GT3F-1: 1 Second

1. For time ranges, see page 829.
2. For sockets and accessory part numbers, see page 838.
3. When power is applied, the NO output contact closes. When power is removed, the timing period begins. When time has elapsed, the NO contact opens.
4. For the timing diagram overview, see page 794.

GT3F-2 Timing Diagrams

GT3F-2 (8-pin)

GT3F-2E (11-pin)

Delayed DPDT Output

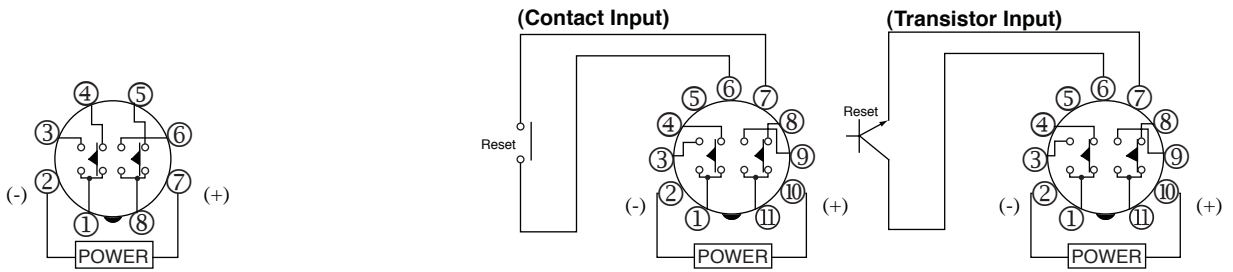

8-Pin Type

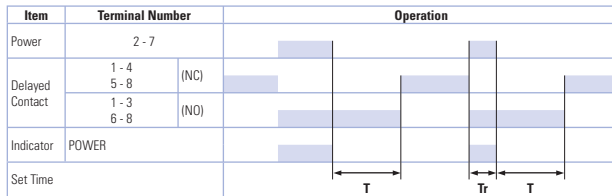

11-Pin Type

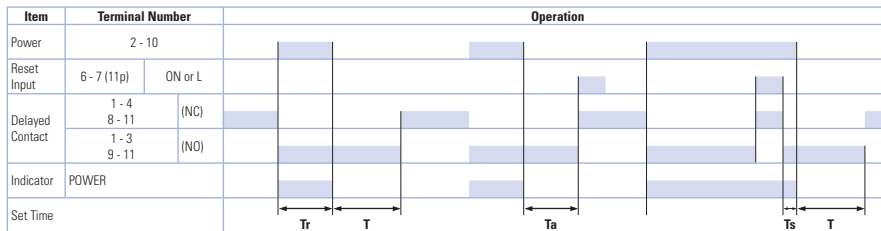

When power is applied, the NO contact closes. When power is removed, the timing period begins. When time has elapsed, the NO contact opens. Optional reset input will return contacts to original state before time elapses.

- T = Set time
- Ta = Shorter than set time
- Ts = 1 Second
- Tr = Minimum Power Application Time
- GT3F-1: 1 Second

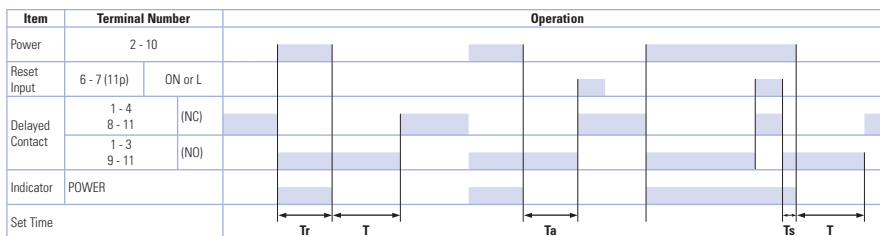

Instructions: Setting GT3F Series Timers



Step 1	Desired Operation	Selection		Remarks
Select a time range that contains the desired period of time.	Base Time Ranges	① Dial Selector	② Time Range Selector	Time range can be selected from 1S and 10S using a flat screwdriver and five different dials of 0 to 1, 0 to 3, 0 to 6, 0 to 18, and 0 to 60 are displayed in the six windows by turning the Dial Selector, allowing for selecting the best suited scale. Note that the switch does not turn infinitely.
	0.1s to 1s	0 to 1	1s	
	0.1s to 3s	0 to 3		
	0.1s to 6s	0 to 6		
	0.1s to 10s	0 to 1	10s	
	0.3s to 30	0 to 3		
	0.6s to 60	0 to 6		
	1.8s to 180s	0 to 18		
6s to 600s	0 to 60			
Step 2				Remarks
The set time is selected by turning the ③ Setting Knob.				Setting Examples: 1. When the Setting Knob ③ is set at 2.5, with Dial Selector ① 0 to 3 and Time Range Selector ② 1S selected, then the set time is 2.5 seconds. 2. When the Setting Knob ③ is set at 5.0, with Dial Selector ① 0 to 60 and Time Range Selector ② 10S selected, then the set time is 500 seconds.

Switches & Pilot Lights

Display Lights

Relays & Sockets

Timers

Terminal Blocks

Circuit Breakers

Instructions: Wiring Inputs

Inputs of GT3F

To avoid electric shock, do not touch the input signal terminal during power voltage application. Never apply the input signals to two or more GT3F timers using the same contact or transistor.

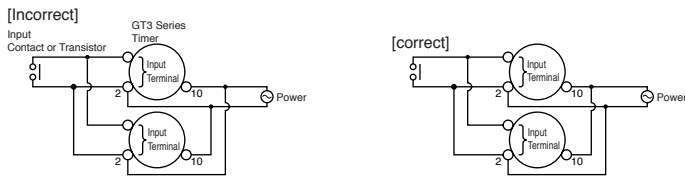

In a transistor circuit for controlling input signals, with its primary and secondary power circuits isolated, do not ground the secondary circuit.

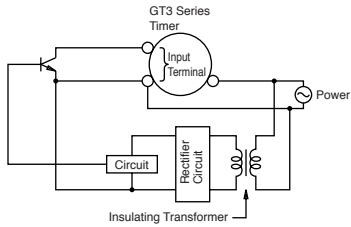

On the GT3F timers, connect the input signals to terminal No.1 and 4 only on the 8-pin type; connect the input signals to terminal No. 6 and 7 only on the 11-pin type. Never apply voltage to other terminals; otherwise, the internal circuit may be damaged.

Input signal lines must be made as short as possible and installed away from power cables and power lines. Use shielded wires or a separate conduit for input wiring.

The GT3F, consisting of a high-impedance circuit, may not be reset due to the influence of an inductive voltage or residual voltage caused by a leakage current. If not reset, connect an RC filter or bleeder resistor between power terminals so that the voltage between power terminals can be reduced to less than 15% of the rated voltage.

## GT3S (Star-Delta) Timers

### Star-Delta



Operation Mode	Rated Input Voltage	Time Range	Output	Contact	Part No.
					8-pin Type
Star-Delta	AF20: 100 to 240V AC (50/60Hz)	Star: 0.05 to 100 sec Star-Delta switching time: 0.05 sec 0.1 sec 0.25 sec 0.5 sec	250V AC/30V DC, 5A (resistive load)	Star: Delayed SPST-NO Delta: Delayed SPST-NO	GT3S-1AF20
				Star: Delayed SPST-NO Delta: Delayed SPST-NO Instantaneous: SPST-NO	GT3S-2AF20

### Time Ranges

① Star Dial Selector		② Star-Delta Switching Time Selector
Dial	Time Range	Time
0-5	0.05 sec - 5 sec	0.05 sec
0-10	0.1 sec - 10 sec	0.1 sec
0-50	0.5 sec - 50 sec	0.25 sec
0-100	1 sec - 100 sec	0.5 sec

### Contact Ratings

Contact Ratings		250V AC/30V DC, 5A (resistive load)
Life	Mechanical	20,000,000 operations minimum
	Electrical	100,000 operations minimum (rated load)

**General Specifications**

<b>Operation System</b>	Solid state CMOS circuitry	
<b>Operation Type</b>	Star-delta	
<b>Time Range</b>	Star side: 0.05 to 100 sec Star-delta switching time: 0.05, 0.1, 0.25, 0.5 sec	
<b>Rated Operational Voltage</b>	100 to 240V AC (50/60Hz)	
<b>Operating Temperature</b>	-10 to +50°C	
<b>Storage Temperature</b>	-30 to +80°C	
<b>Operating Humidity</b>	45 to 85% RH	
<b>Voltage Tolerance</b>	85 to 264V AC	
<b>Repeat Error</b>	±0.2%, ±10 msec	
<b>Voltage Error</b>	±0.2%, ±10 msec	
<b>Temperature Error</b>	±0.2%, ±10 msec	
<b>Setting Error</b>	±10% maximum	
<b>Reset Time</b>	500 msec maximum	
<b>Insulation Resistance</b>	100MΩ minimum	
<b>Dielectric Strength</b>	Between power and output terminals: 2,000V AC, 1 minute Between contacts of different poles: 2,000V AC, 1 minute Between contacts of the same pole: 750V AC, 1 minute	
<b>Vibration Resistance</b>	100 m/sec <sup>2</sup> (Approx. 10G)	
<b>Shock Resistance</b>	Operating extremes: 100m/sec <sup>2</sup> (Approx. 10G) Damage limits: 500m/sec <sup>2</sup> (Approx. 50G)	
<b>Power Consumption (Approx.)</b>	<b>Type GT3S-1</b>	2.3VA (100V AC, 60Hz), 4.0VA (200V AC, 60Hz)
	<b>Type GT3S-2</b>	2.3VA (100V AC, 60Hz), 3.8VA (200V AC, 60Hz)

Switches &amp; Pilot Lights

Display Lights

Relays &amp; Sockets

**Timers**

Terminal Blocks

Circuit Breakers

Operation Charts

Product Series

Internal Connection and Terminal Arrangement

Operation Chart

GT3S-1  
 Star: Delayed SPST-NO  
 Delta: Delayed SPST-NO

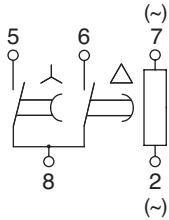

Item	Terminal No.	Operation
Power	2-7	[Power ON bar]
Star Delayed Contact	8-5 (NO)	[Star ON bar from T1 to T2]
Delta Delayed Contact	8-6 (NO)	[Delta ON bar from T2 to T3]
Indicator	Star	[Star ON bar from T1 to T2]
	Delta	[Delta ON bar from T2 to T3]
Set Time		[Timeline with T1, T2, T3 markers]

The star delayed contact goes on when power is turned on and goes off after a set time for the start contact ( $T_1$ ). The delta delayed contact goes on after star-delta switching time ( $T_2$ ) and goes off when power is turned off.  
 $T_1$  = Star ON time (Set Time),  $T_2$  = Star-delta switching time,  $T_3$  = Delta ON time

GT3S-2  
 Star: Delayed SPST-NO  
 Delta: Delayed SPST-NO  
 Instantaneous: SPST-NO

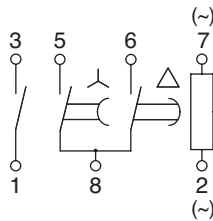

Item	Terminal No.	Operation
Power	2-7	[Power ON bar]
Star Delayed Contact	8-5 (NO)	[Star ON bar from T1 to T2]
Delta Delayed Contact	8-6 (NO)	[Delta ON bar from T2 to T3]
Instantaneous contact	3-1 (NO)	[Instantaneous ON bar from T1 to T3]
Indicator	Star	[Star ON bar from T1 to T2]
	Delta	[Delta ON bar from T2 to T3]
Set Time		[Timeline with T1, T2, T3 markers]

The star delayed contact goes on when power is turned on and goes off after a set time for the star contact ( $T_1$ ). The delta delayed contact goes on after star-delta switching time ( $T_2$ ) and goes off when power is turned off.  
 The instantaneous contact goes on when power is turned on and goes off when power is turned off.  
 $T_1$  = Star ON time (Set Time),  $T_2$  = Star-delta switching time,  $T_3$  = Delta ON time

## GT3W Series – Dual Time Range Timers

**Key features of the GT3W series include:**

- Sequential start, sequential interval, on-delay, recycler, and interval ON timing functions
- 2 time settings in one timer
- 8 selectable operation modes on each model
- Mountable in sockets or flush panel
- Power and output status indicating LEDs
- Time ranges up to 300 hours

**General Specifications**

<b>Operation System</b>		Solid state CMOS Circuit	
<b>Operation Type</b>		Multi-Mode	
<b>Time Range</b>		1: 0.1sec to 6 hours, 3: 0.1sec to 300 hours	
<b>Pollution Degree</b>		2 (IE60664-1)	
<b>Over Voltage Category</b>		III (IE60664-1)	
<b>Rated Operational Voltage</b>	AF20	100-240V AC(50/60Hz)	
	AD24	24V AC(50/60Hz)/24V DC	
	D12	12V DC	
<b>Voltage Tolerance</b>	AF20	85-264V AC(50/60Hz)	
	AD24	20.4-26.4V AC(50/60Hz)/21.6-26.4V DC	
	D12	10.8-13.2V DC	
<b>Disengaging Value of Input Voltage</b>		Rated Voltage x10% minimum	
<b>Range of Ambient Operating Temperature</b>		-10 to +50°C (without freezing)	
<b>Range of Ambient Storage and Transport Temperature</b>		-30 to +75°C (without freezing)	
<b>Range of Relative Humidity</b>		35 to 85%RH (without condensation)	
<b>Atmospheric Pressure</b>		80kPa to 110kPa (Operating), 70kPa to 110kPa (Transport)	
<b>Reset Time</b>		60msec maximum	
<b>Repeat Error</b>		±0.2%, ±10msec*	
<b>Voltage Error</b>		±0.2%, ±10msec*	
<b>Temperature Error</b>		±0.6%, ±10msec*	
<b>Setting Error</b>		±10% maximum	
<b>Insulation Resistance</b>		100MΩ minimum (500V DC)	
<b>Dielectric Strength</b>		Between power and output terminals: 2000V AC, 1 minute Between contacts of different poles: 2000V AC, 1 minute Between contacts of the same pole: 750V AC, 1 minute	
<b>Vibration Resistance</b>		10 to 55Hz amplitude 0.75mm <sup>2</sup> hours in each of 3 axes	
<b>Shock Resistance</b>		Operating extremes: 98m/sec <sup>2</sup> (approx. 10G) Damage limits: 490m/sec <sup>2</sup> (approx. 50G) 3 times in each of 3 axes	
<b>Degree of Protection</b>		IP40 (enclosure), IP20 (socket) (IEC60529)	
<b>Power Consumption (Approx.)</b>	AF20	100V AC/60Hz	2.3VA
		200V AC/60Hz	4.6VA
	AD24 (AC/DC)	1.8VA/0.9W	
<b>Mounting Position</b>		Free	
<b>Dimensions</b>		40Hx 36W x 70 mm	
<b>Weight (Approx.)</b>		72g	

**Contact Ratings**

<b>Allowable Contact Power</b>	960VA/120W	
<b>Allowable Voltage</b>	250V AC/150V DC	
<b>Allowable Current</b>	5A	
<b>Maximum permissible operating frequency</b>	1800 cycles per hour	
<b>Rated Load</b>	1/8HP, 240V AC	
	3A, 240V AC (Resistive)	
	5A, 120V AC/30V DC (Resistive)	
<b>Conditional Short Circuit</b>	Fuse 5A, 250V	
<b>Life</b>	Electrical	100,000 op. minimum (Resistive)
	Mechanical	20,000,000 op. minimum

\* For the value of the error against a preset time, whichever the largest applies.





Part Number List

Part Numbers

Mode of Operation	Output	Contact	Time Range*	Rated Voltage	Pin Configuration	New Part Numbers
A: Sequential Start B: On-delay with course and fine C: Recycler and instaneous D: Recycler outputs (OFF Start) E: Recycler outputs (ON Start) F: Interval ON G: Interval ON Delay H: Sequential Interval	3A, 240V AC	Delayed SPDT + Delayed SPDT	1: 0.1sec - 6 hours *(See Time Range Settings for details.)	100 to 240V AC (50/60Hz)	8 pin	GT3W-A11AF20N
					11 pin	GT3W-A11EAF20N
	24V AC/DC			8 pin	GT3W-A11AD24N	
				11 pin	GT3W-A11EAD24N	
	5A, 120V AC/30V DC (Resistive Load)		12V DC	8 pin	GT3W-A11D12N	
				11 pin	GT3W-A11ED12N	
	3: 0.1sec - 300 hours		100 to 240V AC (50/60Hz)	8 pin	GT3W-A33AF20N	
			24V AC/DC		GT3W-A33AD24N	



1. For timing diagrams and schematics, see page 836.
2. For socket and accessory part number information, see page 838.
3. 8- and 11-pin models differ only in the number of pins (extra pins are not used).
4. For the timing diagram overview, see page 794.
5. \*For details on setting time ranges, see the instructions on page 837.

Time Range Table

Time Range Code: 1			Time Range Code: 3		
Time Range Selector	Scale	Time Range	Time Range Selector	Scale	Time Range
1S	0-1	0.1 sec - 1 sec	1S	0 - 3	0.1 sec - 3 sec
10S		0.3 sec - 10 sec	1M		3 sec - 3 min
10M		15 sec - 10 min	1H		3 min - 3 hours
1S	0 - 6	0.1 sec - 6 sec	1S	0 - 30	0.6 sec - 30 sec
10S		1 sec - 60 sec	1M		36 sec - 30 min
1M		6 sec - 6 min	1H		36min - 30 hours
10M		1 min - 60 min	10H		6 hours - 300 hours
1H		6 min - 6 hours			

Switches & Pilot Lights

Display Lights

Relays & Sockets

Timers

Terminal Blocks

Circuit Breakers

Timing Diagrams/Schematics

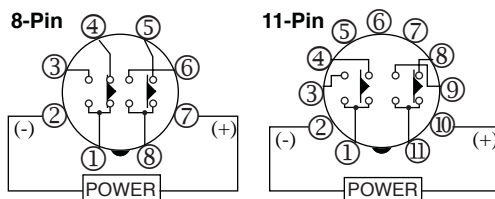

Mode	Operation Chart				Mode	Operation Chart			
A: Sequential Start	Item	Terminal No.	Operation	Description	E: Recycler outputs (ON Start)	Item	Terminal No.	Operation	Description
	Power	2-7	[Timing Diagram]			Power	2-7	[Timing Diagram]	
B: On-delay with course and fine	Item	Terminal No.	Operation	Description	F: Interval ON	Item	Terminal No.	Operation	Description
	Delayed Contact Ry1	1-4 (NC) 1-3 (NO)	[Timing Diagram]	ON after T1 + T2		Delayed Contact Ry1	1-4 (NC) 1-3 (NO)	[Timing Diagram]	ON during T1
C: Recycler and instantaneous	Item	Terminal No.	Operation	Description	G: Interval ON Delay	Item	Terminal No.	Operation	Description
	Delayed Contact Ry2	5-8 (NC) 6-8 (NO)	[Timing Diagram]	OFF during T1 ON during T2		Delayed Contact Ry2	5-8 (NC) 6-8 (NO)	[Timing Diagram]	ON after T1 + T2
D: Recycler outputs (OFF Start)	Item	Terminal No.	Operation	Description	H: Sequential Interval	Item	Terminal No.	Operation	Description
	Indicator	OUT1 OUT2	[Timing Diagram]			Indicator	OUT1 OUT2	[Timing Diagram]	

Switches & Pilot Lights

Display Lights

Relays & Sockets

Timers

Terminal Blocks

Circuit Breakers

## Instructions: Setting GT3W Timer

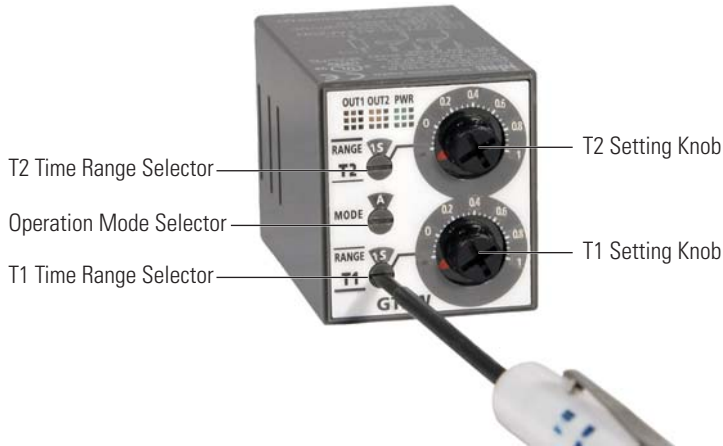

1. The switches should be securely turned using a flat screwdriver 4mm wide (maximum). Note that incorrect setting may cause malfunction. The switches, which do not turn infinitely, should not be turned beyond their limits.
2. Since changing the setting during timer operation may cause malfunction, turn power off before changing.

### Safety Precautions

Special expertise is required to use Electronic Timers.

- All Electronic Timer modules are manufactured under IDEC's rigorous quality control system, but users must add a backup or fail safe provision to the control system when using the Electronic Timer in applications where heavy damage or personal injury may occur should the Electronic Timer fail.
- Install the Electronic Timer according to instructions described in this catalog.
- Make sure that the operating conditions are as described in the specifications. If you are uncertain about the specifications, contact IDEC in advance.
- In these directions, safety precautions are categorized in order of importance to Warning and Caution.

### Warning

Warning notices are used to emphasize that improper operation may cause severe personal injury or death.

- Turn power off to the Electronic timer before starting installation, removal, Wiring, maintenance, and inspection on the Electronic Timer.
- Failure to turn power off may cause electrical shocks or fire hazard.
- Emergency stop and interlocking circuits must be configured outside the Electronic timer. If such a circuit is configured inside the Electronic Timer, failure of the Electronic timer may cause malfunction of the control system, or an accident.

### Caution









Caution notices are used where inattention might cause personal injury or damage to equipment.

- The Electronic Timer is designed for installation in equipment. Do not install the Electronic Timer outside equipment.
- Install the Electronic Timer in environments described in the specifications. If the Electronic Timer is used in places where it will be subjected to high-temperature, high-humidity, condensation, corrosive gases, excessive vibrations, or excessive shocks, then electrical shocks, fire hazard, or malfunction could result.
- Use an IEC60127-approved fuse and circuit breaker on the power and output line outside the Electronic Timer.
- Do not disassemble, repair, or modify the Electronic Timer.
- When disposing of the Electronic Timer, do so as industrial waste.

**GT3 Series  
Accessories**

**DIN Rail Mounting Accessories**

**DIN Rail/Surface Mount Sockets and Hold-Down Springs**

DIN Rail Mount Socket				Applicable Hold-Down Springs	
Style	Appearance	Use with Timers	Part No.	Appearance	Part No.
8-Pin Screw Terminal (dual tier)		GT3A-1, 2, 3 (8-pin) GT3D-1, 2, 3 (8-pin) GT3F-1, 2 (8-pin) GT3W (8-pin) GT3S	SR2P-05		SFA-203
11-Pin Screw Terminal (dual tier)		GT3A-1, 2, 3 (11-pin) GT3A-4, 5, 6 GT3D-1, 2, 3 (11-pin) GT3D-4, 8 GT3F-1, 2 (11-pin) GT3W (11-pin)	SR3P-05		
8-Pin Fingersafe Socket		GT3A-1, 2, 3 (8-pin) GT3D-1, 2, 3 (8-pin) GT3F-1, 2 (8-pin) GT3W (8-pin) GT3S	SR2P-05C		
11-Pin Fingersafe Socket		GT3A-1, 2, 3 (11-pin) GT3A-4, 5, 6 GT3D-1, 2, 3 (11-pin) GT3D-4, 8 GT3F-1, 2 (11-pin) GT3W (11-pin)	SR3P-05C		
8-Pin Screw Terminal		GT3A-1, 2, 3 (8-pin) GT3D-1, 2, 3 (8-pin) GT3F-1, 2 (8-pin) GT3W (8-pin) GT3S	SR2P-06		SFA-202
11-Pin Screw Terminal		GT3A-1, 2, 3 (11-pin) GT3A-4, 5, 6 GT3D-1, 2, 3 (11-pin) GT3D-4, 8 GT3F-1, 2 (11-pin) GT3W (11-pin)	SR3P-06		
DIN Mounting Rail Length 1000mm		—	BNDN1000		

**Installation of Hold-Down Springs  
DIN Rail Mount Socket**

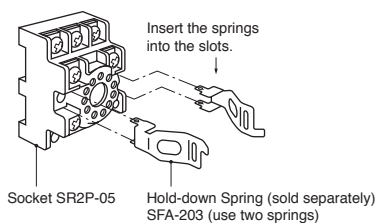
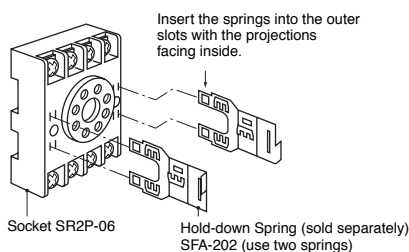

**Panel Mount Socket**

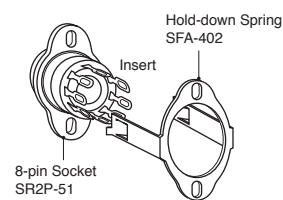

Switches & Pilot Lights

Display Lights

Relays & Sockets



Timers

Terminal Blocks

Circuit Breakers

Panel Mounting Accessories

Panel Mount Sockets and Hold-Down Springs

Panel Mount Socket				Applicable HD Springs	
Style	Appearance	Use with Timers	Part No.	Appearance	Part No.
8-Pin Solder Terminal		GT3A- (8-pin) GT3D- (8-pin) GT3W- (8-pin) GT3F- (8-pin) GT3S	SR2P-51		SFA-402
11-Pin Solder Terminal		GT3A- (11-pin) GT3D- (11-pin) GT3W- (11-pin) GT3F- (11-pin)	SR3P-51		





Switches & Pilot Lights

Display Lights



For information on installing the hold-down springs, see page 838.

Flush Panel Mount Adapter and Sockets that use an Adapter

Accessory	Description	Appearance	Use with Timers	Part No.
Panel Mount Adapter	Adaptor for flush panel mounting GT3 timers		All GT3 timers	RTB-G01
Sockets for use with Panel Mount Adapter	8-pin screw terminal		All 8-pin timers	SR6P-M08G
	11-pin screw terminal		(Shown: SR6P-M08G for Wiring Socket Adapter)	All 11-pin timers
	8-pin solder terminal		All 8-pin timers	SR6P-S08
	11-pin solder terminal		All 11-pin timers	SR6P-S11

Relays & Sockets

Timers

Terminal Blocks

Circuit Breakers



No hold down springs are available for flush panel mounting.

Instructions: Wiring Inputs for GT3 Series

Inputs Inputs

To avoid electric shock, do not touch the input signal terminal during power voltage application.

When connecting the input signal terminals of two or more GT3A timers to the same contact or transistor, the input terminals of the same number should be connected. (Connect Terminals No.2 in common.)

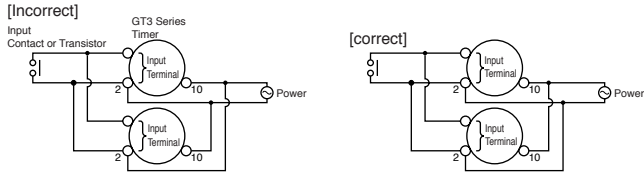

In a transistor circuit for controlling input signals, with its primary and secondary power circuits isolated, do not ground the secondary circuit.

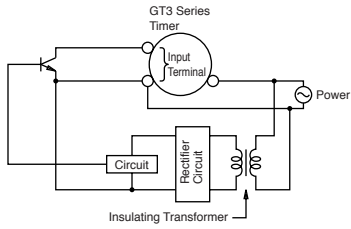

Connect the input signal terminals of the GT3A timers to Terminal No.2 only. Never apply voltage to other terminals; otherwise, the internal circuit may be damaged.

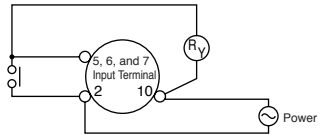

Input signal lines must be made as short as possible and installed away from power cables and power lines. Use shielded wires or a separate conduit for input wiring.

Switches & Pilot Lights

Display Lights

Relays & Sockets

Timers

Terminal Blocks

Circuit Breakers

Inputs Instructions, continued

For contact input, use gold-plated contacts to make sure that the residual voltage is less than 1V when the contacts are closed.

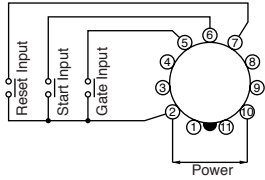

For transistor input, use transistors with the following specifications; VCE = 40V, VCES = 1V or less, IC = 50 mA or more, and ICBO = 50μA or less. The resistance should be less than 1kΩ when the transistor is on. When the output transistor switches on, a signal is input to the timer.

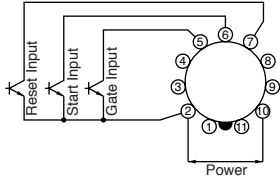

Inputs: GT3A-1, -2, -3

Transistor output equipment such as proximity switches and photoelectric switches can input signals if they are voltage/current output type, with power voltage ranges from 18 to 30V and have 1V. When the signal voltage switches from H to L, a signal is input to the timer

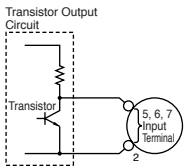

Inputs: GT3A-4, -5, -6

<b>Start Input</b>	The start input initiates a time-delay operation and controls output status.	No-voltage contact inputs and NPN open collector transistor inputs are applicable. 24V DC, 1mA maximum Input response time: 50msec maximum
<b>Reset Input</b>	When the reset input is activated, the time is reset, and contacts return to original state.	
<b>Gate Input</b>	The time-delay operation is suspended while the gate input is on (pause).	

Dimensions

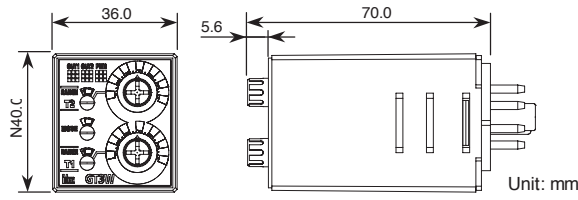

NOTE: GT3W series are UL Listed when used in combination with following IDEC's sockets:  
 GT3W-A11, A33: SR2P-06\* pin type socket.  
 GT3W-A11E: SR3P-05\* pin type socket.  
 (\*-May be followed by A,B,C or U)  
 The socket to be used with these timers are rated:  
 -Conductor Temperature Rating 60°C min.  
 -Use 14AWG max.(2mm<sup>2</sup>max.) Copper conductors only  
 -Terminal Torque 1.0 to 1.3 N-m

Analog GT3 Timer, 8-Pin with SR2P-06

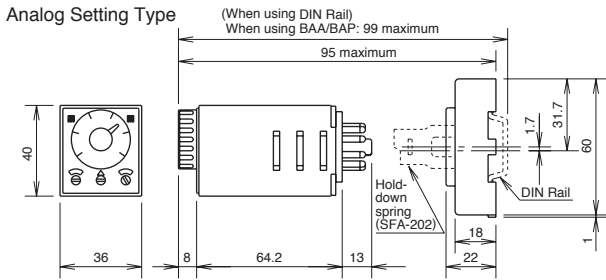

Analog GT3 Timer, 11-Pin with SR3P-06

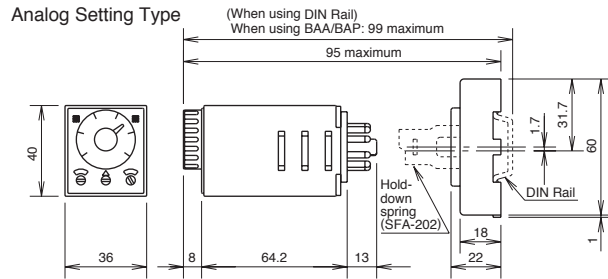

Digital GT3 Timer, 8-Pin with SR2P-06

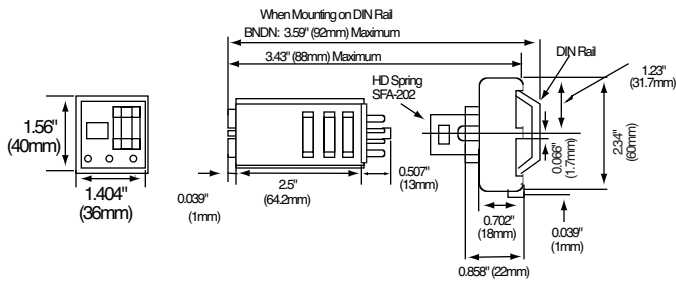

Digital GT3 Timer, 11-Pin with SR3P-06

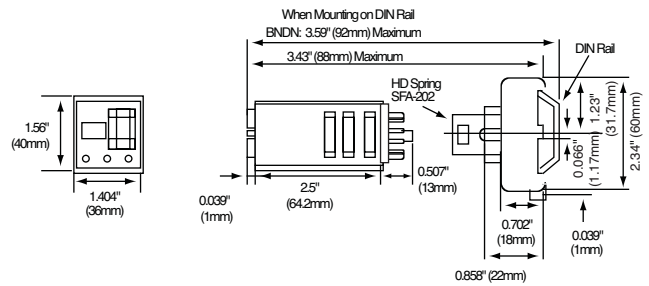

Analog GT3 Timer, 11-Pin with SR3P-05

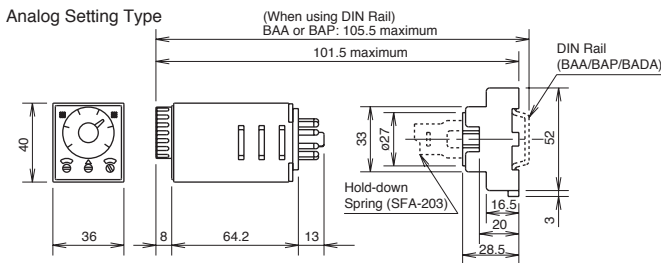

Digital GT3 Timer, 11-Pin with SR3P-05

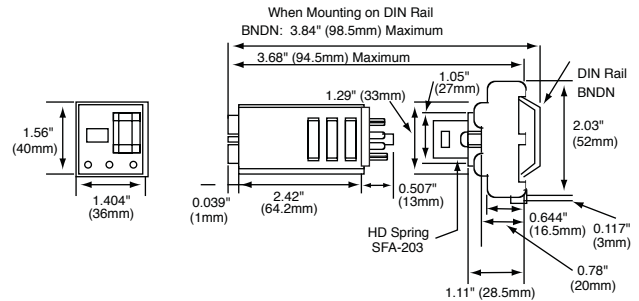

Switches & Pilot Lights

Display Lights

Relays & Sockets

Timers

Terminal Blocks

Circuit Breakers



Panel Mount Adapter

Analog GT3 Timer, 8-Pin and 11-Pin with SR6P-S08 or SR6P-S11

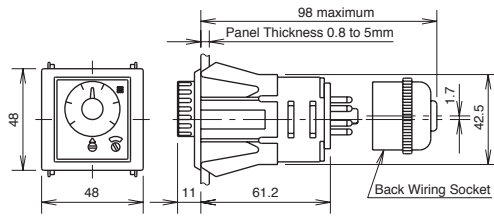

Digital GT3 Timer, 8-Pin and 11-Pin with SR6P-S08 or SR6P-S11

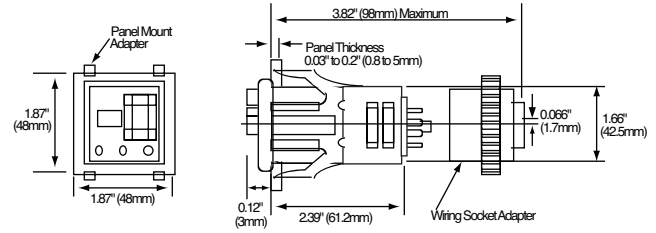

Mounting Hole Layout

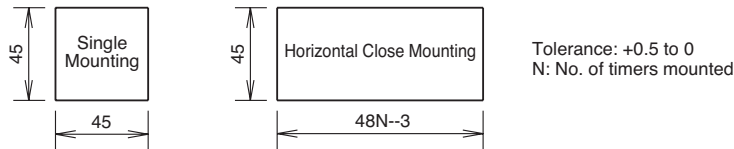

Analog and Digital GT3 Timer, 8-Pin with SR6P-M08G

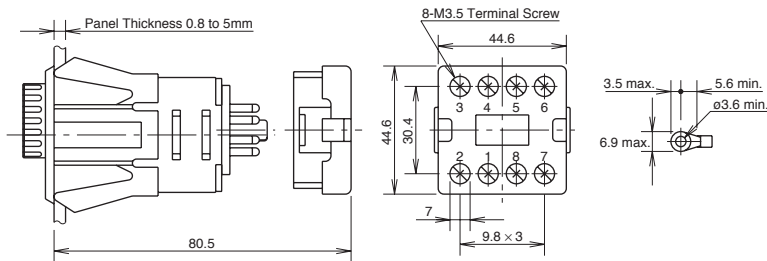

Analog and Digital GT3 Timer, 11-Pin with SR6P-M11G

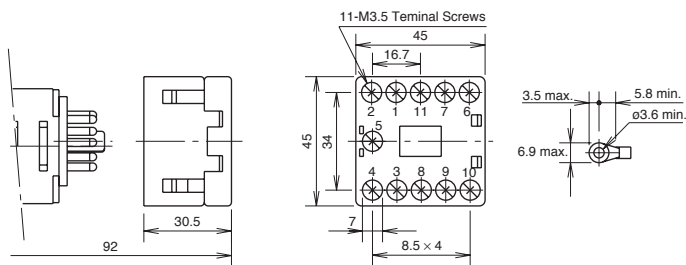

GE1A Series – ON Delay Timers

Single Function

Key features of the GE1A series include:

- DPDT or SPDT + instantaneous SPDT
- 8-pin, octal base
- 8 time ranges
- Repeat error ±0.2% maximum
- Large, clear knob for easy setting
- Instant monitoring of operational status by LED indicators



UL, c-UL Listed  
File No. E55996



Specifications

<b>Rated Operating Voltage</b>	24V AC/DC 100 to 120V AC 220 to 240V AC	
<b>Voltage Tolerance</b>	AC: 85 to 110% DC: 90 to 110%	
<b>Contact Rating</b>	240V AC/5A 24V DC/5A	
<b>Contact Form</b>	DPDT or SPDT+ instantaneous SPDT	
<b>Repeat Error</b>	±0.2% ±10msec maximum	
<b>Voltage Error</b>	±0.5% ±10msec maximum	
<b>Temperature Error</b>	±3% maximum	
<b>Setting Error</b>	±10% maximum	
<b>Reset Time</b>	0.1 sec maximum	
<b>Insulation Resistance</b>	100MΩ minimum (500V DC megger)	
<b>Dielectric Strength</b>	Between power and output terminals: 1,500V AC, 1 minute Between contact circuits: 750V AC, 1 minute	
<b>Vibration Resistance</b>	Damage limits: Amplitude 0.75mm, 10 to 55 Hz Operating extremes: Amplitude 0.5mm, 10 to 55 Hz	
<b>Shock Resistance</b>	Damage limits: 500m/s <sup>2</sup> (Approx. 50G)	
<b>Power Consumption</b>	<b>GE1A-B</b>	24V AC type: 1.6 VA
		24V DC type: 1.0W
		110V AC type: 3.8 VA
	<b>GE1A-C</b>	220V AC type: 7.7 VA
		24V AC type: 2.0 VA
		24V DC type: 0.8W
	110V AC type: 3.5 VA	
	220V AC type: 8.0 VA	
<b>Electrical Life</b>	100,000 operations minimum (at full rated load)	
<b>Mechanical Life</b>	10,000,000 operations minimum	
<b>Operating Temperature</b>	-10 to +55°C (without freezing)	
<b>Operating Humidity</b>	35 to 85% RH (without freezing)	

Switches & Pilot Lights

Display Lights

Relays & Sockets

Timers

Terminal Blocks

Circuit Breakers

Part Numbering List

Mode of Operation	Contact	Output	Rated Voltage	Time Range	Complete Part Number	
ON-Delay	Delayed SPDT + Instantaneous SPDT	24V DC/120V AC, 5A 240V AC, 5A	24V AC/DC	0.1s to 10m	GE1A-B10MAD24	
			110-120V AC		GE1A-B10MA110	
			220-240V AC		GE1A-B10MA220	
			24V AC/DC	0.1m to 10h	GE1A-B10HAD24	
			110-120V AC		GE1A-B10HA110	
			220-240V AC		GE1A-B10HA220	
	Delayed DPDT			24V AC/DC	0.1s to 10m	GE1A-C10MAD24
				110-120V AC		GE1A-C10MA110
				220-240V AC		GE1A-C10MA220
				24V AC/DC	0.1m to 10h	GE1A-C10HAD24
				110-120V AC		GE1A-C10HA110
				220-240V AC		GE1A-C10HA220

Switches & Pilot Lights

Display Lights

Timing Diagrams/Schematics

**GE1A-B**  
Delayed SPDT + Instantaneous SPDT

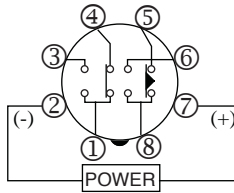

**GE1A-C**  
Delayed DPDT

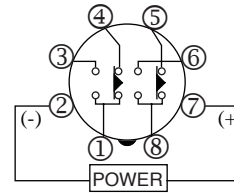

Operation Mode Selection

Relays & Sockets

ON-Delay 1

MODE

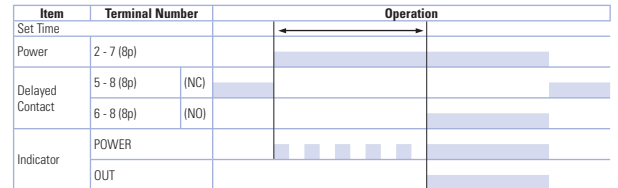
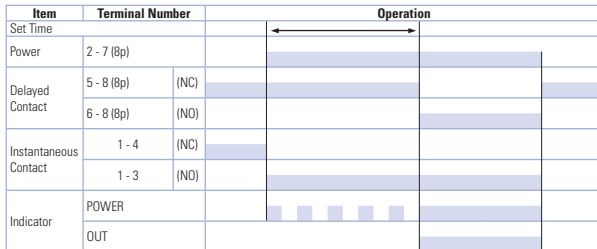

Timers

Terminal Blocks

Circuit Breakers

**Accessories**

**Mounting Accessories & Sockets**

	Style	Appearance	Part No.	
Switches & Pilot Lights	8-Pin Screw Terminal (dual tier)		SR2P-05	
	DIN Rail/Surface Mounting Accessories	8-Pin Fingersafe Socket		SR2P-05C
		8-Pin Screw Terminal		SR2P-06
Display Lights	DIN Mounting Rail Length 1000mm		BNDN1000	
Relays & Sockets	8-Pin Solder Terminal		SR2P-51	
	Panel Mounting Accessories	Screw Terminal Socket		SR6P-M08G
Terminal Blocks		Panel Mount Adapter		GE9Z-AD

**Other Accessories**

	Style	Appearance	Part No.
Circuit Breakers	Dust Cover		GE9Z-C48

Switches & Pilot Lights

Display Lights

Relays & Sockets

Timers

Terminal Blocks

Circuit Breakers

Dimensions

GE1A Timer

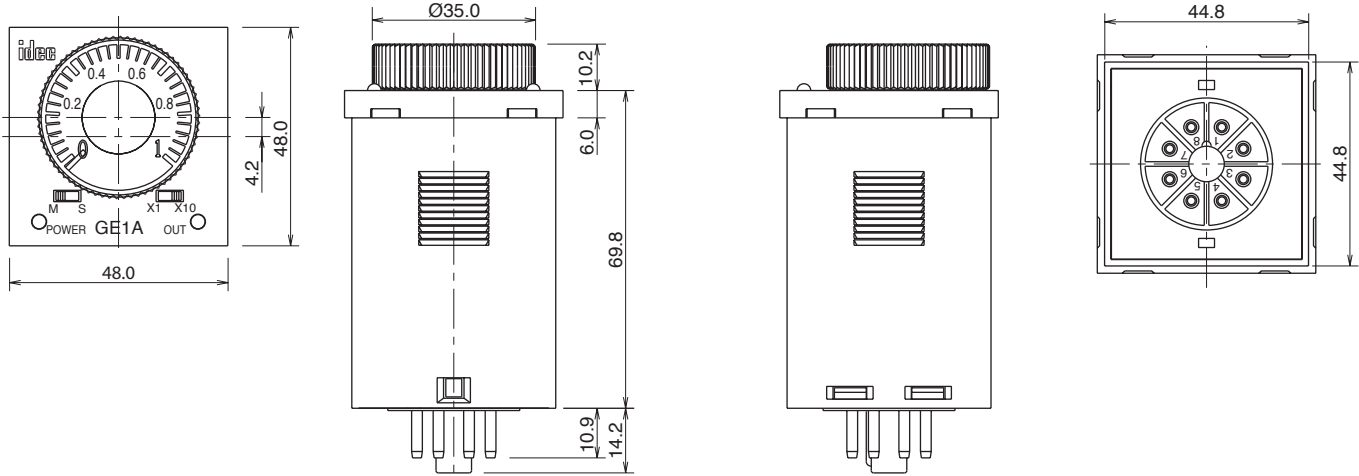

GE1A Timer Panel Cutout

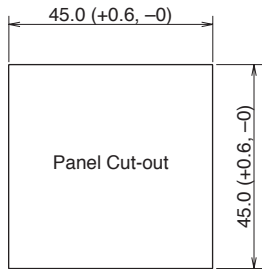

8-Pin SR2P-05

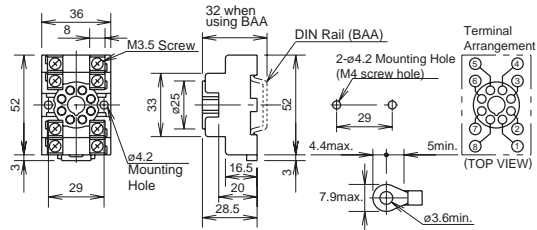

8-Pin SR2P-06

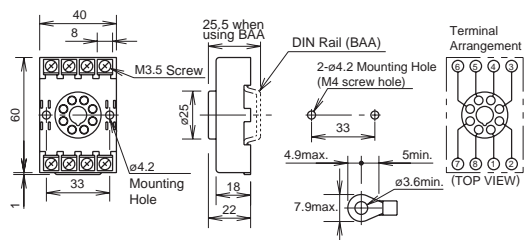

**GT5P Series – ON Delay Timers**

**Key features of the GT5P series include:**

- SPDT, 5A contacts
- 8-pin, octal base
- 9 time ranges
- Repeat error  $\pm 0.2\%$  maximum
- Control settings by hand or screwdriver
- Power ON and timing out LED indicators
- Uses the same sockets and hold down clips as IDEC's RR2P 8-pin relays



UL Recognized  
File No. E55996



CSA Certified  
File No. LR66809



**Specifications**

<b>Rated Operating Voltage</b>	100 to 120V AC (50/60Hz) 200 to 240V AC (50/60Hz) 24V AC/DC 12V DC
<b>Voltage Tolerance</b>	AC type: $\pm 15\%$ DC type: $\pm 10\%$ (ripple 10% maximum)
<b>Contact Rating</b>	<b>Resistive load</b> 120V AC/24V DC, 5A 240V AC, 3A
	<b>Inductive load</b> 240V AC, 0.8A 120V AC, 1.4A 24V DC, 1.7A
<b>Allowable Contact Power (resistive load)</b>	960VA AC 120W DC
<b>Contact Form</b>	SPDT
<b>Voltage</b>	250V AC, 150V DC
<b>Repeat Error</b>	$\pm 0.2\%$ $\pm 10\text{msec}$
<b>Voltage Error</b>	$\pm 0.5\%$ $\pm 10\text{msec}$
<b>Temperature Error</b>	$\pm 3\%$ maximum (over $-10$ to $50^\circ\text{C}$ , reference temperature $20^\circ\text{C}$ )
<b>Setting Error</b>	$\pm 10\%$ maximum
<b>Reset Time</b>	When turning power off after time up: 0.1 sec maximum When turning power off before time up: 1 sec maximum
<b>Insulation Resistance</b>	100M $\Omega$ minimum
<b>Dielectric Strength</b>	2000V AC, 1 minute (except between contacts of the same pole)
<b>Vibration Resistance</b>	100N (approximate 10G)
<b>Shock Resistance</b>	Operating extremes: 100N (approximate 10G) Damage limits: 500N (approximate 50G)
<b>Power Consumption</b>	100V AC type: 1.5VA (at 50Hz) 200V AC type: 1.6VA (at 50Hz) 24V DC type: 0.9W
<b>Electrical Life</b>	100,000 operations minimum (at rated load)
<b>Mechanical Life</b>	20,000,000 operations minimum
<b>Operating Temperature</b>	$-10$ to $+50^\circ\text{C}$
<b>Operating Humidity</b>	45 to 85% RH

1. Inductive load (reference),  $\cos \phi = 0.3$  to  $0.4$  or  $L/R = 15\text{msec}$ .  
2. Minimum applicable load: 5VDC/10mA (reference).

Switches & Pilot Lights  
Display Lights  
Relays & Sockets  
Timers  
Terminal Blocks  
Circuit Breakers

Part Numbering List

Mode of Operation	Contact	Output	Rated Voltage	Time Range	Complete Part No.
ON-Delay	SPDT	24V DC/120V AC, 5A 240V AC, 3A	100 to 120V AC	1S	—
				3S	GT5P-N3SA100
				6S	—
				10S	GT5P-N10SA100
				30S	GT5P-N30SA100
				60S	GT5P-N60SA100
				3M	GT5P-N3MA100
				6M	GT5P-N6MA100
				10M	GT5P-N10MA100
			200 to 240V AC	1S	GT5P-N1SA200
				3S	—
				6S	GT5P-N6SA200
				10S	GT5P-N10SA200
				30S	GT5P-N30SA200
				60S	GT5P-N60SA200
				3M	GT5P-N3MA200
				6M	GT5P-N6MA200
				10M	GT5P-N10MA200
			24V AC/DC	1S	GT5P-N1SAD24
				3S	—
				6S	GT5P-N6SAD24
				10S	GT5P-N10SAD24
				30S	—
				60S	GT5P-N60SAD24
				3M	—
				6M	GT5P-N6MAD24
				10M	GT5P-N10MAD24
			12V DC	1S	—
				3S	—
				6S	—
10S	GT5P-N10SD12				
30S	GT5P-N30SD12				
60S	GT5P-N60SD12				
3M	—				
6M	—				
10M	GT5P-N10MD12				



For sockets and accessories, see page 851.

Switches & Pilot Lights

Display Lights

Relays & Sockets

Timers

Terminal Blocks

Circuit Breakers

Timing Diagram/Schematic/Electrical Life Curves

Switches & Pilot Lights

Display Lights

Relays & Sockets

Timers

Terminal Blocks

Circuit Breakers

SPDT

Operation Mode

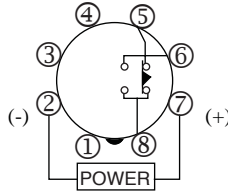

Do not apply voltage to terminals 1, 3, and 4.

ON-Delay

Item	Terminal Number	Operation
Set Time		← Operation →
Power	2 - 7 (8p)	[Bar chart showing power pulse]
Delayed Contact	5 - 8 (8p) (NC)	[Bar chart showing delayed pulse]
	6 - 8 (8p) (NO)	[Bar chart showing delayed pulse]
Indicator	POWER	[Bar chart showing indicator pulse]
	OUT	[Bar chart showing indicator pulse]

Electrical Life Curves

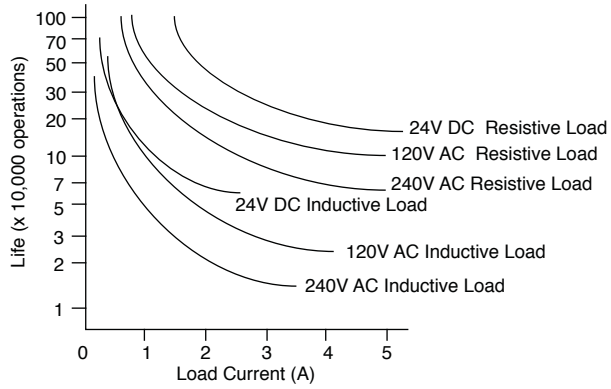



Accessories  
Mounting

Mounting Accessories and Sockets					Applicable Hold-Down Springs	
	Style	Appearance	Use with Timers	Part No.	Appearance	Part No.
DIN Rail/ Surface Mounting Accessories	8-Pin Screw Terminal (dual tier)		GT5P	SR2P-05		SFA-203
	8-Pin Fingersafe Socket		GT5P	SR2P-05C		
	8-Pin Screw Terminal		GT5P	SR2P-06		SFA-202
	DIN Mounting Rail Length 1000mm		—	BNDN1000		
<b>Part Numbers: Mounting Accessories and Sockets</b>					<b>Applicable Hold-Down Springs</b>	
Mounting Accessories	8-Pin Solder Terminal			SR2P-51		SFA-402

Installation of Hold-Down Springs  
DIN Rail Mount Socket

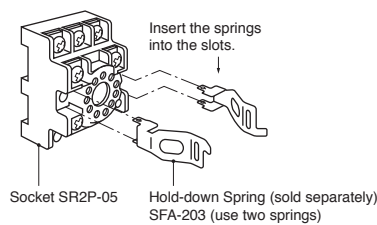
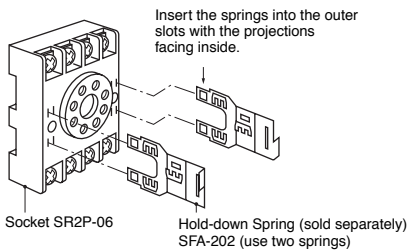

Panel Mount Socket

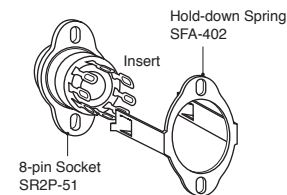

Switches & Pilot Lights

Display Lights

Relays & Sockets

Timers

Terminal Blocks

Circuit Breakers

Dimensions

GT5P Timer, 8-Pin with SR2P-05

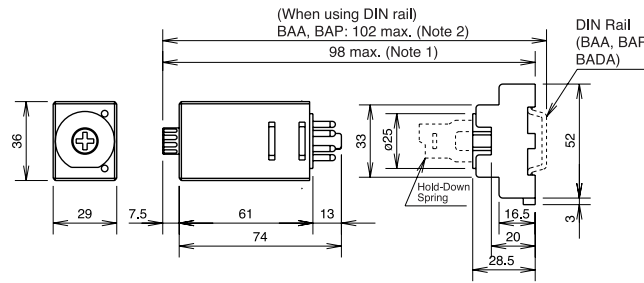

GT5P Timer, 8-Pin with SR2P-06

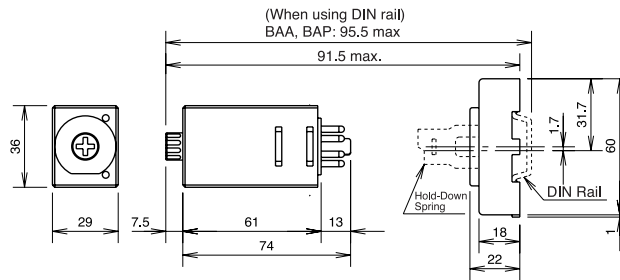

Switches & Pilot Lights

Display Lights

Relays & Sockets

Timers

Terminal Blocks

Circuit Breakers

## GT5Y Series – ON Delay Timers

### Key features of the GT5Y series include:

- 4PDT, 3A or DPDT, 5A contacts
- 4 time ranges
- Repeat error  $\pm 0.2\%$  maximum
- Control settings by hand or screwdriver
- Power ON and timing out LED indicators
- Uses the same sockets and hold-down clips as IDEC's RY4S and RU series relays



UL, c-UL Listed  
File No. E55996

### Specifications

		GT5Y-2	GT5Y-4
<b>Rated Operating Voltage</b>		100 to 120V AC (50/60Hz) 200 to 240V AC (50/60Hz) 24V DC 24V AC 12V DC	
<b>Contact Form</b>		DPDT	4PDT
<b>Rated Load</b>	Resistive Load	220V AC, 5A 30V DC, 5A	220V AC, 3A 30V DC, 3A
	Inductive Load	220V AC, 2A 30V DC, 2.5A	220V AC, 0.8A 30V DC, 1.5A
<b>Allowable Contact Power</b>	Resistive Load	1100VA AC 150W DC	660VA AC 90W DC
	Inductive Load Cos $\phi = 0.3$ L/R = 7msec	440VA AC 75W DC	176VA AC 45W DC
<b>Allowable Voltage</b>		250V AC, 125V DC	
<b>Allowable Current</b>		5A	3A
<b>Temperature Error</b>		$\pm 3\%$ maximum (over $-10$ to $50^\circ\text{C}$ , reference temperature $20^\circ\text{C}$ )	
<b>Setting Error</b>		$\pm 10\%$ maximum	
<b>Reset Time</b>		When turning power off after time up: 0.1 second maximum When turning power off before time up: 1 second maximum	
<b>Insulation Resistance</b>		100M $\Omega$ minimum	
<b>Dielectric Strength</b>		2,000V AC, 1 minute (except between contacts of the same pole)	
<b>Vibration Resistance</b>		100N (approximate 10G)	
<b>Shock Resistance</b>		Operating extremes: 100N (approximate 10G) Damage limits: 500N (approximate 50G)	
<b>Power Consumption</b>		100V AC type: 1.5VA (at 50Hz) 200V AC type: 1.6VA (at 50Hz) 24V DC type: 0.9W	
<b>Electrical Life</b>		500,000 operations minimum (220V AC, 5A)	200,000 operations minimum (110V AC, 3A)
<b>Mechanical Life</b>		50,000,000 operations minimum	
<b>Operating Temperature</b>		$-10$ to $+50^\circ\text{C}$	
<b>Operating Humidity</b>		45 to 85% RH	



1. Minimum applicable load: GT5Y-2: 5V DC, 20mA (reference value); GT5Y-4: 5V DC, 10mA (reference value).
2. Inductive load: cos  $\phi = 0.3$ , L/R=7msec.

**Part Numbering List**

Switches &amp; Pilot Lights

Display Lights

Relays &amp; Sockets

Timers

Mode of Operation	Contact	Output	Rated Voltage	Time Range	Complete Part No.			
ON-Delay	DPDT	220V AC/ 30V DC, 5A	100 to 120V AC	1S/10S/1M/10M	GT5Y-2SN1A100			
				3S/30S/3M/30M	GT5Y-2SN3A100			
				6S/60S/6M/60M	GT5Y-2SN6A100			
			200 to 240V AC	1S/10S/1M/10M	GT5Y-2SN1A200			
				3S/30S/3M/30M	GT5Y-2SN3A200			
				6S/60S/6M/60M	GT5Y-2SN6A200			
			12V DC	1S/10S/1M/10M	GT5Y-2SN1D12			
				3S/30S/3M/30M	GT5Y-2SN3D12			
				6S/60S/6M/60M	GT5Y-2SN6D12			
			24V DC	1S/10S/1M/10M	GT5Y-2SN1D24			
				3S/30S/3M/30M	GT5Y-2SN3D24			
				6S/60S/6M/60M	GT5Y-2SN6D24			
			24V AC	1S/10S/1M/10M	GT5Y-2SN1A24			
				3S/30S/3M/30M	GT5Y-2SN3A24			
				6S/60S/6M/60M	GT5Y-2SN6A24			
				4PDT	220V AC/30V DC, 3A	100 to 120V AC	1S/10S/1M/10M	GT5Y-4SN1A100
							3S/30S/3M/30M	GT5Y-4SN3A100
							6S/60S/6M/60M	GT5Y-4SN6A100
200 to 240V AC	1S/10S/1M/10M	GT5Y-4SN1A200						
	3S/30S/3M/30M	GT5Y-4SN3A200						
	6S/60S/6M/60M	GT5Y-4SN6A200						
12V DC	1S/10S/1M/10M	—						
	3S/30S/3M/30M	GT5Y-4SN3D12						
	6S/60S/6M/60M	—						
24V DC	1S/10S/1M/10M	GT5Y-4SN1D24						
	3S/30S/3M/30M	GT5Y-4SN3D24						
	6S/60S/6M/60M	GT5Y-4SN6D24						
24V AC	1S/10S/1M/10M	GT5Y-4SN1A24						
	3S/30S/3M/30M	GT5Y-4SN3A24						
	6S/60S/6M/60M	GT5Y-4SN6A24						



For sockets and accessories, see page 856.

Terminal Blocks

Circuit Breakers

**Timing Ranges**





Code	Scale	Time Range Indication		Time Range
1S	0 to 10	x 0.1	S	0.1 second to 1 second
10S		x 1	S	0.2 second to 10 seconds
1M		x 0.1	M	1.2 seconds to 1 minute
10M		x 1	M	12 seconds to 10 minutes
3S	0 to 3	x 1	S	0.1 second to 3 seconds
30S		x 10	S	0.5 second to 30 seconds
3M		x 1	M	3 seconds to 3 minutes
30M		x 10	M	30 seconds to 30 minutes
6S	0 to 6	x 1	S	0.1 second to 6 seconds
60S		x 10	S	1 second to 60 seconds
6M		x 1	M	6 seconds to 6 minutes
60M		x 10	M	1 minute to 60 minutes



**Accessories**

**DIN Rail Mounting Accessories**

**DIN Rail/Surface Mount Sockets and Hold-Down Springs**

DIN Rail Mount Socket			Applicable Hold-Down Springs	
Style	Appearance	Part No.	Appearance	Part No.
14-Blade Screw Terminal		SY4S-05		SFA-202
14-Blade Screw Terminal (fingersafe)		SY4S-05C		
DIN Mounting Rail Length 1000mm		BNDN1000		



**Panel Mounting Accessories**

**Part Numbers: Panel Mount Socket and Hold-Down Springs**

Panel Mount Socket			Applicable Hold-Down Springs	
Style	Appearance	Part No.	Appearance	Part No.
14-Blade Solder Terminal		SY4S-51		SFA-302

**PCB Mounting Accessories**

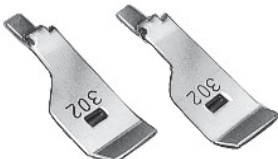
**Part Numbers: PCB Mount Sockets with Applicable Hold-Down Springs**

PCB Mount Socket			Applicable Hold-Down Springs	
Style	Appearance	Part No.	Appearance	Part No.
14 Blade, PCB Terminal		SY4S-61		SFA-302
14 Blade, PCB Terminal		SY4S-62		SY4S-02F1

Switches & Pilot Lights

Display Lights

Relays & Sockets

Timers

Terminal Blocks

Circuit Breakers

Dimensions

GT5Y Timer, Blade with SY4S-05

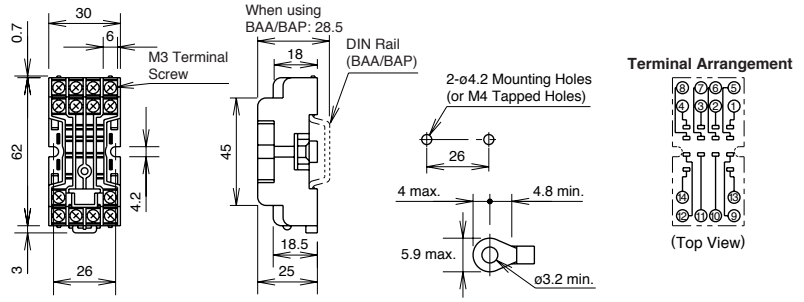
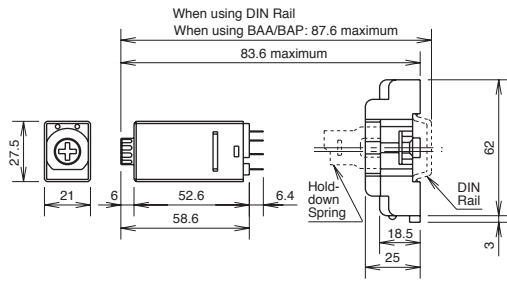

Switches & Pilot Lights

Display Lights

Relays & Sockets

Timers

Terminal Blocks

Circuit Breakers

## General Instructions for All Timer Series

Switches & Pilot Lights

### Load Current

With inductive, capacitive, and incandescent lamp loads, inrush current more than 10 times the rated current may cause welded contacts and other undesired effects. The inrush current and steady-state current must be taken into consideration when specifying a timer.

### Contact Protection

Switching an inductive load generates a counter-electromotive force (back EMF) in the coil. The back EMF will cause arcing, which may shorten the contact life and cause imperfect contact. Application of a protection circuit is recommended to safeguard the contacts.

### Temperature and Humidity

Use the timer within the operating temperature and operating humidity ranges and prevent freezing or condensation. After the timer has been stored below its operating temperature, leave the timer at room temperature for a sufficient period of time to allow it to return to operating temperatures before use.

### Environment

Avoid contact between the timer and sulfurous or ammonia gases, organic solvents (alcohol, benzine, thinner, etc.), strong alkaline substances, or strong acids. Do not use the timer in an environment where such substances are prevalent. Do not allow water to run or splash on the timer.

Display Lights

Relays & Sockets

### Vibration and Shock

Excessive vibration or shocks can cause the output contacts to bounce, the timer should be used only within the operating extremes for vibration and shock resistance. In applications with significant vibration or shock, use of hold down springs or clips is recommended to secure a timer to its socket.

### Time Setting

The time range is calibrated at its maximum time scale; so it is desirable to use the timer at a setting as close to its maximum time scale as possible. For a more accurate time delay, adjust the control knob by measuring the operating time with a watch before application.

### Input Contacts

Use mechanical contact switch or relay to supply power to the timer. When driving the timer with a solid-state output device (such as a two-wire proximity switch, photoelectric switch, or solid-state relay), malfunction may be caused by leakage current from the solid-state device. Since AC types comprise a capacitive load, the SSR dielectric strength should be two or more times the power voltage when switching the timer power using an SSR.

Generally, it is desirable to use mechanical contacts whenever possible to apply power to a timer or its signal inputs. When using solid state devices, be cautious of inrushes and back-EMF that may exceed the ratings on such devices. Some timers are specially designed so that signal inputs switch at a lower voltage than is used to power the timer (models designated as "B" type).

### Timing Accuracy Formulas

Timing accuracies are calculated from the following formulas:

$$\text{Repeat Error} = \pm \frac{1 \times \text{Maximum Measured Value} - \text{Minimum Measured Value} \times 100\%}{2 \text{ Maximum Scale Value}}$$

$$\text{Voltage Error} = \pm \frac{T_v - T_r \times 100\%}{T_r}$$

T<sub>v</sub>: Average of measured values at voltage V  
T<sub>r</sub>: Average of measured values at the rated voltage

$$\text{Temperature Error} = \pm \frac{T_t - T_{20} \times 100\%}{T_{20}}$$

T<sub>t</sub>: Average of measured values at °C  
T<sub>20</sub>: Average of measured values at 20°C

$$\text{Setting Error} = \pm \frac{\text{Average of Measured Values} - \text{Set Value} \times 100\%}{\text{Maximum Scale Value}}$$

Timers

Terminal Blocks

Circuit Breakers